



**TIPPER
TRANSPORTER
BUILDER
BOX
PRO
PRO BREAK
PRAKTI
PRAKTI DUMPER
WOOD
EGO**

TIPPER	3
TRANSPORTER	9
BUILDER	17
BOX	23
PRO, PRO BREAK, PRAKTI, PRAKTI DUMPER, WOOD	29
ECO	45



TIPPER 3617/2



PURPOSE: trailer with hydraulic tipping system
COMFORT: robust welded construction
SAFETY: all sides open and can be removed easily
FACILITIES: 3-side tipping from 3217/2 model
CONSTRUCTION: steel floor standard in braked versions 2515 CS, aluminium sides standard from 3015, aluminium floor in 4020/3



ANWENDUNG: Anhänger mit hydraulischem Kippsystem
BEQUEMLICHKEIT: feste geschweißte Konstruktion
SICHERHEIT: alle Bordwände aufklappbar und abnehmbar
EINRICHTUNGEN: 3-Seitenkipper ab 3217/2 Modell
KONSTRUKTION: Stahlboden ab 2515 CS, Alubordwände ab 3015, Aluboden im 4020/3



UTILISATION: remorque professionnelle équipée d'un système hydraulique de basculement.
COMMODITÉ: construction robuste soudée, protégée contre la corrosion
SÉCURITÉ: possibilité d'ouvrir et de démonter toutes les ridelles
AGREMENTS: tribenne à partir du modèle 3217/2
CONSTRUCTION: plancher en acier en série à partir du modèle 2515 CS, ridelles en aluminium en série à partir du modèle 3015, plancher alu en série en 4020/3



PRZEZNACZENIE: profesjonalna przyczepa wyposażona w hydrauliczny system wywrotu
WYGODA: wytrzymała konstrukcja spawana, zabezpieczenie antykorozyjne
BEZPIECZEŃSTWO: możliwość otworzenia i zdemontowania wszystkich burt
UDOGODNIENIA: możliwość wywrotu na trzy strony od modelu 3217/2
KONSTRUKCJA: podłoga stalowa standard od modelu 2515 CS, burtki aluminiowe w standardzie od modelu 3015, podłoga aluminiowa od 4020/3

- steel floor standard in braked versions 2515 CS, aluminium sides standard from 3015, aluminium floor in 4020/3
- Stahlboden ab 2515 CS, Alubordwände ab 3015, Aluboden im 4020/3
- plancher en acier en série à partir du modèle 2515 CS, ridelles en aluminium en série à partir du modèle 3015, plancher alu en série uniquement en 4020/3
- podłoga stalowa standard od modelu 2515 CS, burty aluminiowe w standardzie od modelu 3015, podłoga aluminiowa w 4020/3



TIPPER 3015/2

- tie down points
- Zurrösen
- anneaux d'arrimage
- uchwyty do mocowania ładunku

- additional security latch • Sicherheitsverriegelung
- verrouillage de sécurité • zapięcie bezpieczeństwa

- alu sides, standard (model 3617/2C)
- Alubordwände, standard (Modell 3617/2C)
- ridelles en alu, standard (modèle 3617/2C)
- burty ALU, standard (model 3217/2C)



TIPPER 3617/2C

- robust welded construction
- feste geschweißte Konstruktion
- construction robuste soudée
- wytrzymała konstrukcja spawana

- ramps as accessory from 3217/2 C
- Auffahrrampen unter der Ladefläche als Option ab 3217/2 C S
- rampes sous le plancher en option à partir de 3217/2 C S
- najazdy pod powierzchnią transportową w opcji od modelu 3217/2 C S



TIPPER 3617/2C



- remote control with magnet (2515 C S)
- Fernbedienung mit dem Magnet (2515 C S)
- télécommande avec aimant (2515 C S)
- pilot do sterowania z magnesem (2515 C S)



- hydraulic tilting system
- hydraulisches Kippsystem
- système de soulèvement hydraulique
- hydrauliczny układ podnoszenia

- battery and accessory toolbox, easy accessible (4020/3 C)
- Batterie im ALU-Gehäuse (4020/3 C)
- coffre à batterie et accessoires (4020/3 C) facilement accessible
- łatwo dostępna skrzynia na akumulator i akcesoria (4020/3 C)



3-side tipping (3217/2 C, 3617/2 C, 4020/3 C) • 3-Seite Kippen (3217/2 C, 3617/2 C, 4020/3 C)
tribenne à partir du modèle (3217/2 C, 3617/2 C, 4020/3 C) • uchył na trzy strony (3217/2 C, 3617/2 C, 4020/3 C)



TIPPER



1 alu sides, Alubordwände, ridelles en alu, burty ALU



2 flat cover, Flachplane, bâche plate, pokrowiec płaski



3 alu extensions, Alubordwandaufsatz, réhausses de ridelles en alu, burty ALU BIS



4 mesh welded steel extensions 60 cm, geschweißter Stahl-Gitteraufsatz 60 cm, réhausses de ridelles grillagées soudées 60cm, burty BIS siatkowe spawane 60 cm



5 steel welded extensions 60 cm, geschweißte Stahl Aufsatzbordwände 60 cm, réhausses de ridelles soudées en acier 60cm, Burty BIS stalowe spawane pełne 60 cm



6 steel extensions 30cm, Stahlbordwandaufsatz 30cm, réhausses de ridelles en acier 30cm, burty BIS stal 30cm



8 spare wheel, Ersatzrad, roue de secours, koło zapasowe



7 plywood infill, Bordwände mit der Siebdruckausfüllung, remplissage des ridelles en bois, wypełnienie burt sklejka

	1	2	3	4	5	6	7	8
TIPPER 2515/2 *	<input type="checkbox"/>	<input type="checkbox"/>	<input type="checkbox"/>	<input type="checkbox"/>	<input type="checkbox"/>	<input type="checkbox"/>	<input type="checkbox"/>	<input type="checkbox"/>
TIPPER 2515 S, 2515/2 S **	<input type="checkbox"/>	<input type="checkbox"/>	<input type="checkbox"/>	<input type="checkbox"/>	<input type="checkbox"/>	<input type="checkbox"/>	<input type="checkbox"/>	<input type="checkbox"/>
TIPPER 3015/2 C S	<input checked="" type="checkbox"/>	<input type="checkbox"/>	<input type="checkbox"/>	<input type="checkbox"/>	<input type="checkbox"/>	<input type="checkbox"/>	-	<input type="checkbox"/>
TIPPER 3217/2 C S	<input checked="" type="checkbox"/>	<input type="checkbox"/>	<input type="checkbox"/>	<input type="checkbox"/>	<input type="checkbox"/>	-	-	<input type="checkbox"/>
TIPPER 3617/2 C S	<input checked="" type="checkbox"/>	<input type="checkbox"/>	<input type="checkbox"/>	<input type="checkbox"/>	<input type="checkbox"/>	-	-	<input type="checkbox"/>
TIPPER 4020/3C	<input checked="" type="checkbox"/>	-	-	-	-	-	-	<input type="checkbox"/>

■ standard □ option - unavailable

* - non-braked,
** - braked,

ungebremst, non freiné,
gebremst, freiné,

niehamowany
hamowany



9 automatic jockey wheel,
Automatikstützrad,
roue jockey automatique,
koło podporowe automatyczne



10 front rail, vordere Reling,
porte-échelle avant, reling przedni



11 cover 140cm, Plane 140 cm,
bâche haute 140cm,
pokrowiec 140cm



13 shock absorbers, Achsstoßdämpfer,
amortisseurs, amortyzatory

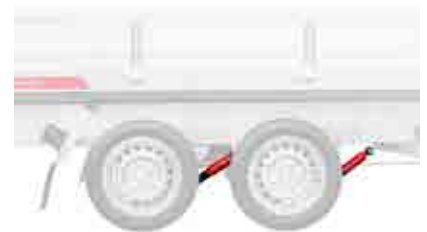

12 prop stands, Seitenstützen,
béquilles latérales, podpory boczne



15 steel ramps 2,5m, Auffahrrampen Stahl 2,5m,
rampes de chargement en acier 2,5m,
najazdy stalowe 2,5 m



16 aluminium ramps 2,5m, Auffahrrampen Alu 2,5m,
rampes en alu 2,5m, najazdy ALU 2,5 m



14 AKS, Antischlingerkupplung,
AKS, AKS

	9	10	11	12	13	14	15	16
—***	<input type="checkbox"/>	<input type="checkbox"/>	<input type="checkbox"/>	<input type="checkbox"/>	<input type="checkbox"/>	<input type="checkbox"/>	<input type="checkbox"/>	<input type="checkbox"/>
<input type="checkbox"/> ▲	<input type="checkbox"/>	<input type="checkbox"/>	<input type="checkbox"/>	<input type="checkbox"/>	<input type="checkbox"/>	<input type="checkbox"/>	<input type="checkbox"/>	<input type="checkbox"/>
■	<input type="checkbox"/>	<input type="checkbox"/>	<input type="checkbox"/>	<input type="checkbox"/>	<input type="checkbox"/>	<input type="checkbox"/>	<input type="checkbox"/>	<input type="checkbox"/>
■	<input type="checkbox"/>	<input type="checkbox"/>	<input type="checkbox"/>	<input type="checkbox"/>	<input type="checkbox"/>	<input type="checkbox"/>	<input type="checkbox"/>	<input type="checkbox"/>
■	<input type="checkbox"/>	<input type="checkbox"/>	<input type="checkbox"/>	<input type="checkbox"/>	<input type="checkbox"/>	<input type="checkbox"/>	<input type="checkbox"/>	<input type="checkbox"/>
■	<input type="checkbox"/>	<input type="checkbox"/>	<input type="checkbox"/>	<input type="checkbox"/>	<input type="checkbox"/>	<input type="checkbox"/>	<input type="checkbox"/>	<input type="checkbox"/>

*** - standard jockey wheel in standard,
roue de jockey en série,

Standardstützrad in Serienausstattung
w standardzie koło podporowe zwykłe

▲ - standard 2515 CS 1500kg

MODEL	GVWR(kg)	LOAD CAPACITY(kg)	INTERNAL DIMENSIONS (mm)	SUSPENSION	BRAKES	TILTING DIRECTIONS	WHEELS	FLOOR	SIDES
MODELL	zGG (kg)	NUTZLAST(kg)	LADEFLÄCHE (mm)	AUFHÄNGUNG	BREMSE	KIPPRICHTUNGEN	RÄDER	BODEN	BORDWANDE
MODÈLE	PTAC (kg)	CAPACITÉ DE CHARGE(kg)	DIMENSIONS INTÉRIEURES (mm)	SUSPENSION	FREINS	BENNE / TRIBENNE	ROUES	PLANCHER	RIDELLES
MODEL	DMC (kg)	ŁADOWNOŚĆ(kg)	POWIERZCHNIA ŁADUNKOWA (mm)	ZAWIESZENIE	HAMULEC	LICZBA STRON UCHYLEŃ	KOŁA	PODŁOGA	BURTY
TIPPER 2515/2 [M]	500 - 750	408	2540x1510x300	2 x 750 kg	-		165 R13	P	S
TIPPER 2515 C S [M]	800 - 1300	877	2540x1510x300	1 x 1350 kg	+		165 R13C	S	S
TIPPER 2515 C S [E]*	800 - 1300	877	2540x1510x300	1 x 1350 kg	+		165 R13C	S	S
TIPPER 2515 C S [M+E]*	800 - 1300	866	2540x1510x300	1 x 1350 kg	+		165 R13C	S	S
TIPPER 2515 C S [M]	800 - 1500	982	2540x1510x300	1 x 1500 kg	+		195/50 R13C	S	S
TIPPER 2515 C S [E]	800 - 1500	1066	2540x1510x300	1 x 1500 kg	+		195/50 R13C	S	S
TIPPER 2515 C S [M+E]	800 - 1500	877	2540x1510x300	1 x 1500 kg	+		195/50 R13C	S	S
TIPPER 2515/2 C S [M]	800 - 1500	918	2540x1510x300	2 x 1350 kg	+		165 R13C	S	S
TIPPER 2515/2 C S [E]	800 - 1500	883	2540x1510x300	2 x 1350 kg	+		165 R13C	S	S
TIPPER 2515/2 C S [M+E]	800 - 1500	879	2540x1510x300	2 x 1350 kg	+		165 R13C	S	S
TIPPER 2515/2 C S [M]	1000 - 2000	1416	2540x1510x300	2 x 1350 kg	+		165 R13C	S	S
TIPPER 2515/2 C S [E]	1000 - 2000	1381	2540x1510x300	2 x 1350 kg	+		165 R13C	S	S
TIPPER 2515/2 C S [M+E]	1000 - 2000	1377	2540x1510x300	2 x 1350 kg	+		165 R13C	S	S
TIPPER 3015/2 C S [M]	1600-2700	2020	3040x1510x300	2 x 1350 kg	+		195/50 R13C	S	A
TIPPER 3015/2 C S [E]	1600-2700	1989	3040x1510x300	2 x 1350 kg	+		195/50 R13C	S	A
TIPPER 3015/2 C S [M+E]	1600-2700	1985	3040x1510x300	2 x 1350 kg	+		195/50 R13C	S	A
TIPPER 3015/2 C S [M]	1600-3000	2319	3040x1510x300	2 x 1500 kg	+		195/50 R13C	S	A
TIPPER 3015/2 C S [E]	1600-3000	2284	3040x1510x300	2 x 1500 kg	+		195/50 R13C	S	A
TIPPER 3015/2 C S [M+E]	1600-3000	2280	3040x1510x300	2 x 1500 kg	+		195/50 R13C	S	A
TIPPER 3217/2 C S [E]	2700-3500	2682	3240x1700x300	2 x 1800 kg	+		195/50 R13C	S	A
TIPPER 3217/2 C S [M+E]	2700-3500	2678	3240x1700x300	2 x 1800 kg	+		195/50 R13C	S	A
TIPPER 3617/2 C S [E]	2700-3500	2666	3650x1700x300	2 x 1800 kg	+		195/50 R13C	S	A
TIPPER 3617/2 C S [M+E]	2700-3500	2662	3650x1700x300	2 x 1800 kg	+		195/50 R13C	S	A
TIPPER 4020/3C 3.ST [M+E]	2700-3500	2520	4050x1990x300	3 x 1350 kg	+		195/50 R13C	A	A



2 non-braked axles 750 kg each
2 ungebremste Achsen jeweils 750 kg
2 essieux non freinés 750kg chacun
2 niehamowane osie 750 kg każda



1 braked axle
1 Achse gebremst
1 essieu freiné
1 oś hamowana



2 braked axles
2 Achse gebremst
2 essieux freinés
2 osie hamowane



3 braked axles
3 Achse gebremst
3 essieux freinés
3 osie hamowane

[M] - manual

[E] - electric

[M+E] - manual + electric

[P] - PLYWOOD / SIEBDRUCK
BOIS / SKLEJKKA

[S] - STEEL / STAHL
ACIER / STAL

[A] - ALU

Dear all! Thank you for your interest in our products. We make every effort to ensure that the information contained in this catalogue is up-to-date and accurate. We would like to inform you that due to the continuous improvement of our products, we are not responsible for the content of the catalogue and the information contained therein is not binding, and their nature is only informative, they do not constitute an offer within the meaning of civil law. This catalogue does not contain any promise or guarantee, also regarding the updating, correction, supplementation and quality of the information. All information contained in this catalogue, as well as the described products and services may be changed or updated by Temared Sp. z o.o. The "TEMARED" trademark, as well as its products, logos, symbols and slogans are the property of Temared Sp. z o.o. Unauthorized use of these trademarks is strictly prohibited.

Sehr geehrte Damen und Herren! Herzlichen Dank für Ihr Interesse an unseren Produkten. Wir bemühen uns unsererseits, dass die in diesem Katalog enthaltenen Informationen aktuell und korrekt sind. Wir möchten Sie darauf hinweisen, dass wir aufgrund der ständigen Verbesserung unserer Produkte keine Verantwortung für den Inhalt des Katalogs übernehmen und die darin enthaltenen Informationen unverbindlich sind, rein informativen Charakter haben und kein Angebot im Sinne des Zivilrechts darstellen. Dieser Katalog enthält keinerlei Versprechungen oder Garantien, auch nicht hinsichtlich der Aktualität, Korrektheit, Ergänzung und Qualität der Informationen. Alle in diesem Katalog enthaltenen Informationen sowie die beschriebenen Produkte und Dienstleistungen können von Temared Sp. z o.o. ohne vorherige Ankündigung geändert oder aktualisiert werden. Die Marke "TEMARED" sowie ihre Produkte, Logos, Symbole und Slogans sind Eigentum der Temared Sp. z o.o. Die unberechtigte Verwendung dieser Marken ist strengstens untersagt.

Mesdames et Messieurs, nous remercions de votre intérêt pour nos produits. Toutes les informations de ce catalogue ont été élaborées sur la base des meilleures informations disponibles et contrôlées avec le plus grand soin. Cependant il n'est pas possible d'exclure toute erreur liée aux modifications de nos produits que nous nous appliquons constamment à corriger ou modifier. C'est pourquoi les données proposées n'impliquent aucune obligation, garantie ni explicite ni implicite particulièrement quant à la nature, la commercialisation, l'aptitude pour les applications prévues. Nous nous réservons le droit de réaliser des modifications ou changements sans notification préalable. TEMARED SP Z O.O. a le droit d'exécuter les changements décrits ci-dessus aux informations, aux produits et aux services à tout moment. Les photos incluses dans ce catalogue appartiennent exclusivement à TEMARED SP Z O.O. TEMARED SP Z O.O. détient l'ensemble des droits de propriété de logo, de la marque de TEMARED, de ses symboles, noms commerciaux et slogans. Il est interdit d'utiliser le logo ou la marque de TEMARED.

Szanowni Państwo! Bardzo dziękujemy za zainteresowanie naszymi produktami. Ze swojej strony dokładamy wszelkich starań aby zapewnić aktualność i dokładność informacji zawartych w tym katalogu. Pragniemy poinformować, że ze względu na ciągłe udoskonalenie produktów nie ponosimy odpowiedzialności w związku z treścią katalogu i informację w nim zawartą nie są wiążące, a ich charakter jest wyłącznie informacyjny, nie stanowią one oferty w rozumieniu prawa cywilnego. Niniejszy katalog nie zawiera żadnego przyrzeczenia lub gwarancji, także odnośnie aktualizacji, korekcyj, uzupełnienia i jakości informacji. Wszystkie informacje zawarte w tym katalogu, jak również opisane produkty i usługi mogą być bez wcześniejszego zawiadomienia zmieniane lub aktualizowane przez Temared Sp. z o.o. Znak towarowy „TEMARED”, a także jej produkty, logo, symbole i slogany są własnością Temared Sp. z o.o. Nieuprawnione używanie tych znaków towarowych jest surowo zabronione.



TRANSPORTER 3015 / 2



PURPOSE: series of universal platforms with wheels underneath
COMFORT: comfortable loading height, easy accessible from all sides
SECURITY: solid, U-bolt tie down points
CONVENIENCE: all sides foldable and removable
CONSTRUCTION: bolted steel frame



ZWECK: Serie von Universalanhängern mit Rädern unter der Transportfläche
KOMFORT: praktische Höhe der Transportfläche
SICHERHEIT: Bodenhalterungen aus robusten Bügeln
PRAKTIKABILITÄT: alle Bordwände können geöffnet und demontiert werden
KONSTRUKTION: geschraubte Stahlanhänger



UTILISATION: série de remorques universelles avec les roues sous le plancher
COMFORT: plancher à une hauteur permettant le chargement facile et pratique
SÉCURITÉ: poignées de fixation solides dans le plancher
COMMODITÉS: toutes les ridelles ouvrables et amovibles
CONSTRUCTION: boulonnée, en acier



PRZEZNACZENIE: seria uniwersalnych przyczep z kołami pod powierzchnią transportową
WYGODA: dogodna wysokość powierzchni transportowej
BEZPIECZEŃSTWO: uchwyty do mocowania pasów zabezpieczających wykonane z solidnych cybantów
UDOGODNIENIA: wszystkie burty uchylane i demontowalne
KONSTRUKCJA: skrucana stalowa

TRANSPORTER 2515

- rebust bolted frame
- starker Rahmen, geschraubt
- le chasis robuste- boulonné
- wytrzymała rama skręcana



- leaf spring suspension (optional in 2515, 2515/2, 3015/2)
- Blattfederaufhängung bei (erhältlich 2515, 2515/2, 3015/2)
- l'amortisseur (option en 2515, 2515/2, 3015/2)
- resor (opcja w modelach 2515, 2515/2, 3015/2)

- loading area on higher level
- Transportfläche auf größerer Höhe
- szurface de transport à une hauteur plus élevée
- powierzchnia transportowa na wyższej wysokości

TRANSPORTER 2515



- plywood anti-slip floor
- Rutschsicherer wasserfester Siebdruckboden
- plancher en contreplaqué marine et antidérapant
- podłoga ze sklejki wodoodpornej antypoślizgowej



TRANSPORTER 3217/2

- comfortable and solid latches
- Bequeme und robuste Bordwandverschlüsse
- grenouillères pratiques et solides
- wygodne i solidne zamki zapinające burty
- all posts easily removable
- alle Eckrungen einfach ausnehmbar
- tous les poteaux sont amovibles
- łatwo demontowane słupki



TRANSPORTER 3015 / 2

TRANSPORTER 3217/2

- optional, ramps shafts behind the light beam
- Auahrrampen hinter der Lichtleiste als Zubehör
- emplacement pour rangement des rampes derrière la plaque d'éclairage en option
- opcjonalne najazdy umieszczone za tablicą rejestracyjną



- tie-down points
- Gürtelhalterungen
- Anneaux d'arrimage
- solidne uchwyty pasów

TRANSPORTER 3217/2

- Sides foldable and removable
- alle Bordwände können geönet und demontiert werden
- Ridelles ouvrables et amovibles
- wszystkie burty otwierane i demontowalne



TRANSPORTER 3617/2 C



- wheels under the floor
- Räder unter der Transportfläche
- Roues sous le plancher
- koła pod powierzchnią transportową



TRANSPORTER 3617/2 C

- Alu sides optional, starting from 3217/2 as standard
- Alu-Bordwände als Option und ab Modell 3217/2 im Standard
- Ridelles en alu en option, à partir du modèle 3217/2 en série
- burty alu w opcji, od modelu 3217/2 standard



TRANSPORTER 3617/2 C



1 alu sides (30 cm), Alubordwände (30 cm)
ridelles en alu (30 cm), burty ALU (30 cm)



2 alu extensions (30 cm),
Alubordwandaufsatz (30 cm),
réhausses de ridelles en alu (30 cm),
burty ALU BIS (30 cm)



3 mesh welded steel extensions 60 cm
geschweißter Stahl-Gitteraufsatz 60 cm,
réhausses de ridelles grillagées soudées 60 cm,
burty BIS siatkowe spawane 60 cm



4 steel welded extensions 60 cm,
geschweißte Stahl Aufsatzbordwände 60 cm,
réhausses de ridelles soudées en acier 60 cm,
Burty BIS stalowe spawane pełne 60 cm



5 steel extensions 30 cm,
Stahlbordwandaufsatz 30 cm,
réhausses de ridelles en acier 30 cm,
burty BIS stal 30 cm



6 flat cover, Flachplane,
bâche plate, pokrowiec płaski



7 spare wheel, Ersatzrad,
roue de secours, koło zapasowe

	1	2	3	4	5	6	7
TRANSPORTER 2515, 2515/2	<input type="checkbox"/>	<input type="checkbox"/>	<input type="checkbox"/>	<input type="checkbox"/>	<input type="checkbox"/>	<input type="checkbox"/>	<input type="checkbox"/>
TRANSPORTER 2515 C, 2515/2 C	<input type="checkbox"/>	<input type="checkbox"/>	<input type="checkbox"/>	<input type="checkbox"/>	<input type="checkbox"/>	<input type="checkbox"/>	<input type="checkbox"/>
TRANSPORTER 3015/2	<input type="checkbox"/>	<input type="checkbox"/>	<input type="checkbox"/>	<input type="checkbox"/>	<input type="checkbox"/>	<input type="checkbox"/>	<input type="checkbox"/>
TRANSPORTER 3217/2 C	<input checked="" type="checkbox"/>	<input type="checkbox"/>	<input type="checkbox"/>	<input type="checkbox"/>	-	<input type="checkbox"/>	<input type="checkbox"/>
TRANSPORTER 3617/2 C	<input checked="" type="checkbox"/>	<input type="checkbox"/>	<input type="checkbox"/>	<input type="checkbox"/>	-	<input type="checkbox"/>	<input type="checkbox"/>



8 Front rail bolted / ladder rack,
vordere Reling geschraubt,
Porte échelle avant boulonné,
reling przedni skręcany



9 cover 140 cm,
Plane 140 cm,
bâche haute 140 cm,
pokrowiec 140 cm



10 Prop stand 2 pcs.,
hintere Abstellstütze 2 Stk.
Béquille arrière 2 pièces,
podpory tylne

11 alu ramps 250 cm,
Aluauffahrrampen 250 cm,
rampes en alu 250 cm,
najazdy alu 250 cm



12 Ramp shafts,
Rampenschächte,
étagères pour rampes,
kieszonki najazdowe
pod pow. trans.



13 standard jockey wheel,
Standardstützrad,
roue jockey standard,
manualne koło podporowe



14 automatic jockey wheel,
Automatikstützrad,
roue jockey automatique,
koło podporowe automatyczne



15 shock absorbers,
Achsstoßdämpfer,
amortisseurs,
amortyzatory

8	9	10	11	12	13	14	15
<input type="checkbox"/>	<input type="checkbox"/>	<input type="checkbox"/>	<input type="checkbox"/>	<input type="checkbox"/>	<input checked="" type="checkbox"/>	-	-
<input type="checkbox"/>	<input type="checkbox"/>	<input type="checkbox"/>	<input type="checkbox"/>	<input type="checkbox"/>	<input checked="" type="checkbox"/>	<input type="checkbox"/>	<input type="checkbox"/>
<input type="checkbox"/>	<input type="checkbox"/>	<input type="checkbox"/>	<input type="checkbox"/>	<input type="checkbox"/>	<input checked="" type="checkbox"/>	-	<input type="checkbox"/>
<input type="checkbox"/>	-	<input type="checkbox"/>	<input type="checkbox"/>	<input type="checkbox"/>	<input checked="" type="checkbox"/>	<input type="checkbox"/>	<input type="checkbox"/>
<input type="checkbox"/>	-	<input type="checkbox"/>	<input type="checkbox"/>	<input type="checkbox"/>	<input checked="" type="checkbox"/>	<input type="checkbox"/>	<input type="checkbox"/>

TRANSPORTER



MODEL	GVWR (kg)	LOAD CAPACITY (kg)	INTERNAL DIMENSIONS (mm)	SUSPENSION	WHEELS	BRAKES	FLOOR	SIDES
MODELL	zGG (kg)	NUTZLAST (kg)	LADEFLÄCHE (mm)	AUFHÄNGUNG	RÄDER	BREMSE	BODEN	BORDWANDE
MODÈLE	PTAC (kg)	CAPACITÉ DE CHARGE(kg)	DIMENSIONS INTÉRIEURES (mm)	SUSPENSION	ROUES	FREINS	PLANCHER	RIDELLES
MODEL	DMC (kg)	ŁADOWNOŚĆ (kg)	POWIERZCHNIA ŁADUNKOWA (mm)	ZAWIESZENIE	KOŁA	HAMULCE	PODŁOGA	BURTY
TRANSPORTER 2515	300 - 750	565	2545 x 1530 x 400		155/70 R13	-	P	S
TRANSPORTER 2515 R	300 - 750	539	2545 x 1530 x 400		155/70 R13	-	P	S
TRANSPORTER 2515/2	300 - 750	520	2545 x 1530 x 400		155/70 R13	-	P	S
TRANSPORTER 2515/2 R	300 - 750	488	2545 x 1530 x 400		155/70 R13	-	P	S
TRANSPORTER 3015	300 - 750	504	2545 x 1530 x 400		155/70 R13	-	P	S
TRANSPORTER 3015 R	300 - 750	478	2545 x 1530 x 400		155/70 R13	-	P	S
TRANSPORTER 3015/2	300 - 750	509	3040 x 1530 x 400		155/70 R13	-	P	S
TRANSPORTER 3015/2 R	300 - 750	477	3040 x 1530 x 400		155/70 R13	-	P	S
TRANSPORTER 2515 C	800 - 1300	1019	2545 x 1530 x 400		165 R13C	+	P	S
TRANSPORTER 2515 C	800 - 1500	1191	2545 x 1530 x 400		195/50 R13C	+	P	S
TRANSPORTER 2515/2 C	800 - 1500	1143	2545 x 1530 x 400		165/70 R13	+	P	S
TRANSPORTER 2515/2 C	1000 - 2000	1640	2545 x 1530 x 400		165 R13C	+	P	S
TRANSPORTER 3217/2 C	800 - 1500	1065	3250 x 1710 x 300		165/70 R13	+	P	A
TRANSPORTER 3217/2 C	1000 - 2000	1547	3250 x 1710 x 300		195/50 R13C	+	P	A
TRANSPORTER 3217/2 C	1600 - 2700	2222	3250 x 1710 x 300		195/50 R13C	+	P	A
TRANSPORTER 3617/2 C	800 - 1500	1053	3650 x 1710 x 300		165/70 R13	+	P	A
TRANSPORTER 3617/2 C	1000 - 2000	1532	3650 x 1710 x 300		195/50 R13C	+	P	A
TRANSPORTER 3617/2 C	1600 - 2700	2214	3650 x 1710 x 300		195/50 R13C	+	P	A



750kg axle on 2 leaf springs
750 kg Achse mit zwei Blattfedern
750kg essieu 2 ressorts
750kg oś na 2 resorach



2x750kg axle on 2 leaf springs
2x750 kg Achse mit vier Blattfedern
2x750kg essieu 2 ressorts
2x750kg oś na 2 resorach



1 non-braked axle
1 Achse ungebremst
1 essieu non freiné
1 oś niehamowana



2 non-braked axles
2 ungebremste Achsen
2 essieux non freinés
2 niehamowane osie



1 braked axle
1 Achse gebremst
1 essieu freiné
1 oś hamowana



2 braked axles
2 Achse gebremst
2 essieux freinés
2 osie hamowane

[P] - PLYWOOD / SIEBDRUCK / BOIS / SKLEJKA

[S] - STEEL / STAHL / ACIER / STAL

[A] - ALU

Dear all! Thank you for your interest in our products. We make every effort to ensure that the information contained in this catalogue is up-to-date and accurate. We would like to inform you that due to the continuous improvement of our products, we are not responsible for the content of the catalogue and the information contained therein is not binding, and their nature is only informative, and they do not constitute an offer within the meaning of civil law. This catalogue does not contain any promise or guarantee, also regarding the updating, correction, supplementation and quality of the information. All information contained in this catalogue, as well as the described products and services may be changed or updated by Temared Sp. z o.o. The "TEMARED" trademark, as well as its products, logos, symbols and slogans are the property of Temared Sp. z o.o. Unauthorized use of these trademarks is strictly prohibited.

Sehr geehrte Damen und Herren! Herzlichen Dank für Ihr Interesse an unseren Produkten. Wir bemühen uns unsererseits, dass die in diesem Katalog enthaltenen Informationen aktuell und korrekt sind. Wir möchten Sie darauf hinweisen, dass wir aufgrund der ständigen Verbesserung unserer Produkte keine Verantwortung für den Inhalt des Katalogs übernehmen und die darin enthaltenen Informationen unverbindlich sind, rein informativen Charakter haben und kein Angebot im Sinne des Zivilrechts darstellen. Dieser Katalog enthält keinerlei Versprechungen oder Garantien, auch nicht hinsichtlich der Aktualität, Korrektheit, Ergänzung und Qualität der Informationen. Alle in diesem Katalog enthaltenen Informationen sowie die beschriebenen Produkte und Dienstleistungen können von Temared Sp. z o.o. ohne vorherige Ankündigung geändert oder aktualisiert werden. Die Marke "TEMARED" sowie ihre Produkte, Logos, Symbole und Slogans sind Eigentum der Temared Sp. z o.o. Die unberechtigte Verwendung dieser Marken ist strengstens untersagt.

Mesdames et Messieurs, nous remercions de votre intérêt pour nos produits. Toutes les informations de ce catalogue ont été élaborées sur la base des meilleures informations disponibles et contrôlées avec le plus grand soin. Cependant il n'est pas possible d'exclure toute erreur liée aux modifications de nos produits que nous nous appliquons constamment à corriger ou modifier. C'est pourquoi les données proposées n'impliquent aucune obligation, garantie ni explicite ni implicite particulièrement quant à la nature, la commercialisation, l'aptitude pour les applications prévues. Nous nous réservons le droit de réaliser des modifications ou changements sans notification préalable. TEMARED SP Z O.O. a le droit d'exécuter les changements décrits ci-dessus aux informations, aux produits et aux services à tout moment. Les photos incluses dans ce catalogue appartiennent exclusivement à TEMARED SP Z O.O. TEMARED SP Z O.O. détient l'ensemble des droits de propriété de logo, de la marque de TEMARED, de ses symboles, noms commerciaux et slogans. Il est interdit d'utiliser le logo ou la marque de TEMARED.

Szanowni Państwo! Bardzo dziękujemy za zainteresowanie naszymi produktami. Ze swojej strony dokładamy wszelkich starań aby zapewnić aktualność i dokładność informacji zawartych w tym katalogu. Pragniemy poinformować, że ze względu na ciągłe udoskonalenie produktów nie ponosimy odpowiedzialności w związku z treścią katalogu i informacje w nim zawarte nie są wiążące, a ich charakter jest wyłącznie informacyjny, nie stanowią one oferty w rozumieniu prawa cywilnego. Niniejszy katalog nie zawiera żadnego przyrzeczenia lub gwarancji, także odnośnie aktualizacji, korekcy, uzupełnienia i jakości informacji. Wszystkie informacje zawarte w tym katalogu, jak również opisane produkty i usługi mogą być bez wcześniejszego zawiadomienia zmieniane lub aktualizowane przez Temared Sp. z o.o. Znak towarowy „TEMARED”, a także jej produkty, logo, symbole i slogany są własnością Temared Sp. z o.o. Nieuprawnione używanie tych znaków towarowych jest surowo zabronione.



BUILDER 3 2615



PURPOSE: trailer series for transporting construction machinery
COMFORT: walkable sides along whole length of the trailer
SECURITY: ramp support, stabilising and supporting under loading
CONVIENIENCE: springs to make lowering and raising of the ramp easier
CONSTRUCTION: welded frame and robust drawbar



ZWECK: eine Reihe von Anhängern für den Transport von Baumaschinen
KOMFORT: die Möglichkeit, über die ganze Länge der Bordwände zu gehen
SICHERHEIT: Stützen, die die Auffahrrampe stabilisieren
PRAKTIKABILITÄT: Federn zum leichteren Senken und Heben der Auffahrrampe
KONSTRUKTION: geschweißter Rahmen und robuste Deichsel



UTILISATION: série de remorques pour le transport de machines de construction
COMFORT: possibilité de marcher sur ridelles
SÉCURITÉ: supports permettant la stabilisation du hayon
COMMODITÉS: ressorts facilitant l'abaissement et le lavage de la rampe
CONSTRUCTION: châssis soudé et timon robuste



PRZEZNACZENIE: seria przyczep do przewozu maszyn budowlanych
WYGODA: możliwość chodzenia po całej długości burt
BEZPIECZEŃSTWO: podpory stabilizujące najazd
UDOGODNIENIA: sprężyny ułatwiające opuszczanie i podnoszenie najazdu
KONSTRUKCJA: spawana rama nośna oraz wytrzymały dyszel

- light and robust aluminium ramps (optional)
- leichte und robuste Alu-Auffahrampen (als Zubehör)
- rampes en aluminium légères et en même temps très résistantes
- lekkie a zarazem bardzo wytrzymałe najazdy aluminiowe (opcja)

BUILDER 3015 S

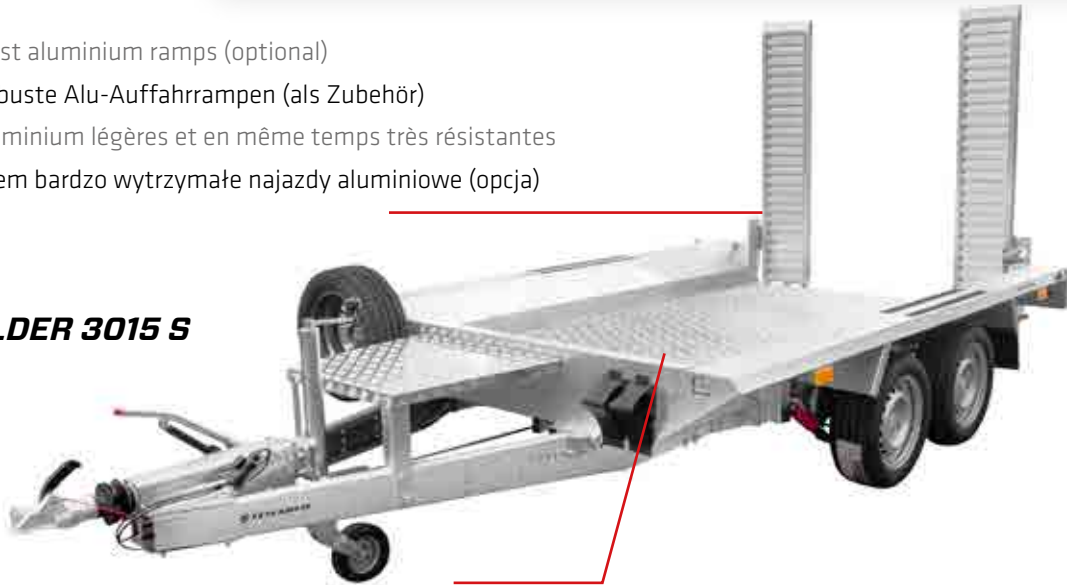

- riffled aluminium floor (optional), low centre of mass ensures stability
- korrosionsfreier Aluboden (Option), tiefer Schwerpunkt sorgt für sicheren Transport der Ladung
- plancher en aluminium (en option) résistant à la corrosion, centre de gravité bas assurant un transport de marchandises en toute sécurité
- niekorodująca podłoga aluminiowa (opcja), niski środek ciężkości zapewnia bezpieczne przewożenie ładunków
- walkable sides
- Möglichkeit, über die ganze Länge der Bordwände zu gehen
- possibilité de marcher sur les ridelles
- możliwość chodzenia po całej długości burt

- ramp support
- Stütze, die die Auffahrrampe stabilisiert
- support de stabilisation du hayon
- podpora stabilizująca najazd

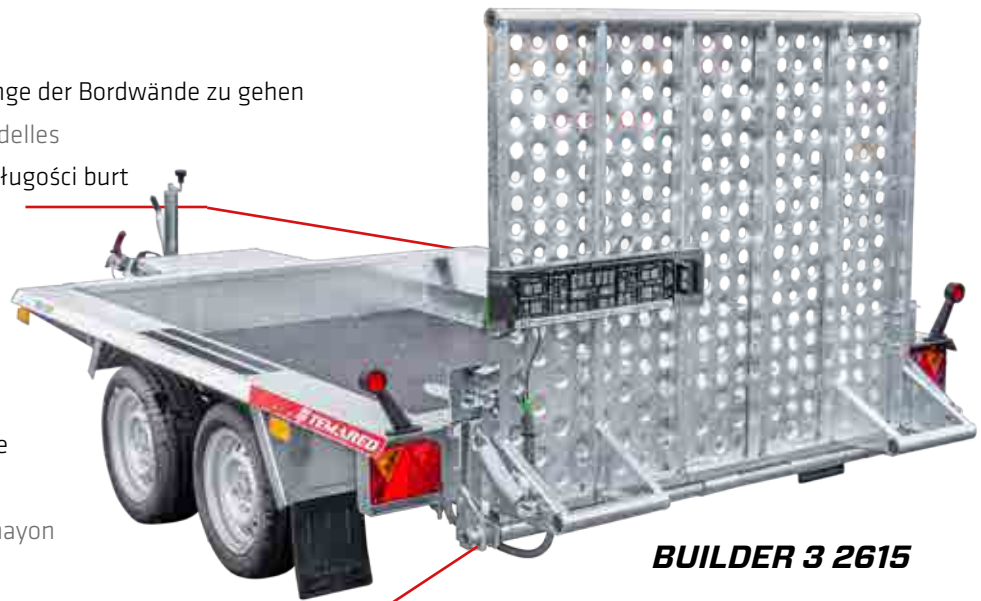

BUILDER 3 2615

- tie down points
- Zurrbügel
- anneaux d'arrimage
- zaczepy pasów

- digger bucket support
- Baggerschaufelablage
- support de godet
- podpora łyżki

- anti-slip waterresistant plywood floor
- Rutschsicherer wasserfester Siebdruckboden
- plancher en contreplaqué marine antidérapant
- podłoga ze sklejki wodoodpornej antypoślizgowej



BUILDER 4018/3

- full width ramp
- durchgehende Auffahrrampe
- hayon
- najazd pełny



BUILDER 4018/3

- robust welded construction
- Robuste geschweißte Konstruktion
- ronstruktion robuste soudée
- wytrzymała spawana konstrukcja



BUILDER 3 2615



1 spare wheel, vertical
Ersatzrad senkrecht
roue de secours verticalement,
koło zapasowe pionowe



2 spare wheel,
Ersatzrad,
roue de secours,
koło zapasowe pod podporą łyżki



4 AKS,
Antischlingerkupplung,
AKS, AKS

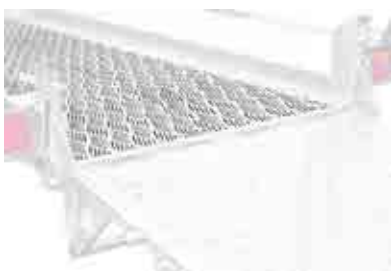

6 alu floor,
Aluminiumboden,
plancher en aluminium,
podłoga alu



3 shock absorbers, Achsstoßdämpfer,
amortisseurs, amortyzatory



5 automatic jockey wheel, Automatikstützrad,
roue jockey automatique, koło podporowe automatyczne



7 exchange ramps into alu,
Wechsel der Auffahrampen zu Aluminium
échange de rampes contre celles en alu,
wymiana najazdów na alu

	1	2	3	4	5	6	7
BUILDER 3 2615 S	<input type="checkbox"/>	<input type="checkbox"/>	<input type="checkbox"/>	<input type="checkbox"/>	<input checked="" type="checkbox"/>	-	<input type="checkbox"/>
BUILDER 3 3015 S	<input type="checkbox"/>	<input type="checkbox"/>	<input type="checkbox"/>	<input type="checkbox"/>	<input checked="" type="checkbox"/>	<input type="checkbox"/>	<input type="checkbox"/>
BUILDER 3 3516, 3516/3 S	<input type="checkbox"/>	<input type="checkbox"/>	<input type="checkbox"/>	<input type="checkbox"/>	<input checked="" type="checkbox"/>	<input type="checkbox"/>	<input type="checkbox"/>
BUILDER 3 4018, 4018/3 S	<input type="checkbox"/>	<input type="checkbox"/>	<input type="checkbox"/>	<input type="checkbox"/>	<input checked="" type="checkbox"/>	<input type="checkbox"/>	<input type="checkbox"/>

■ standard □ option - unavailable

- automatic jockey wheel standard
- Automatikstützrad in Serienausstattung
- roue jockey automatique en série
- koło podporowe z automatem składania w standardzie

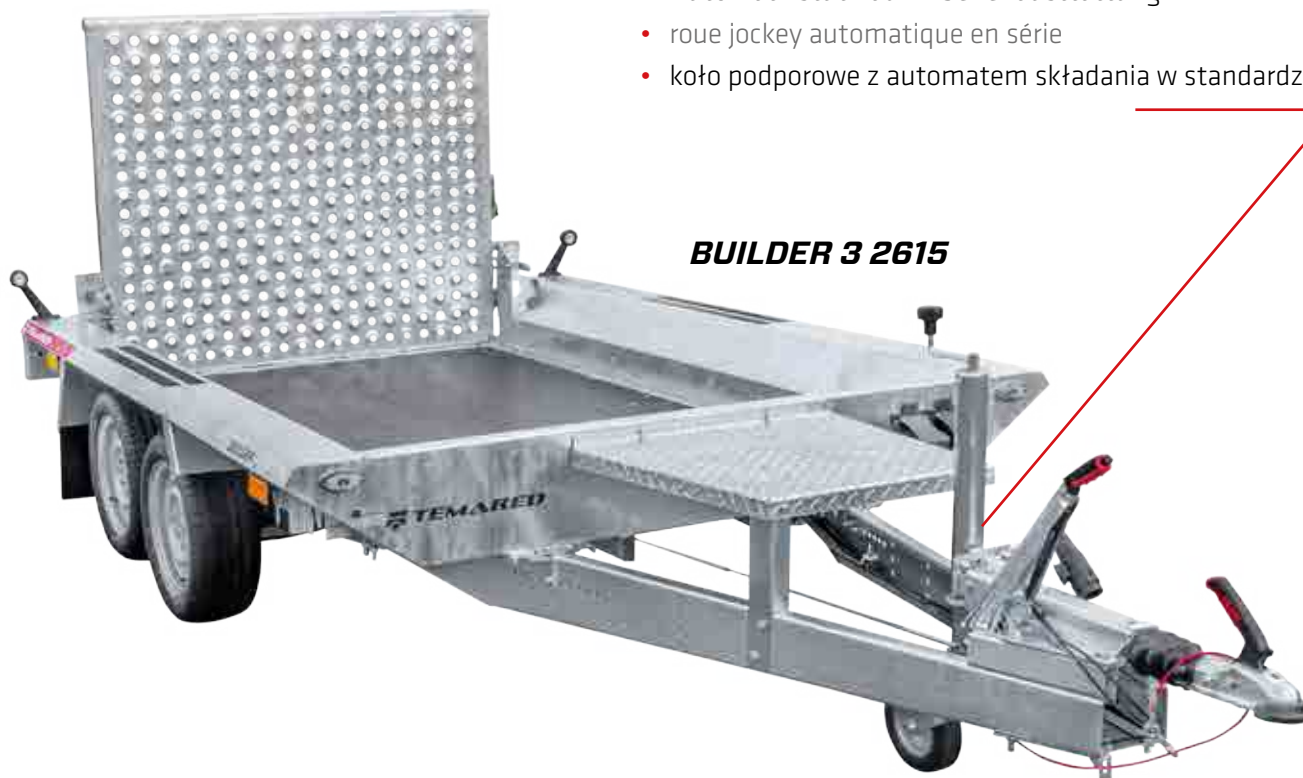

- robust overrun device
- robuste Auflaufeinrichtung
- commandes de freinage solide
- solidne urządzenie najazdowe



MODEL	GVWR(kg)	LOAD CAPACITY(kg)	INTERNAL DIMENSIONS (mm)	SUSPENSION	WHEELS	FLOOR
MODELL	zGG (kg)	NUTZLAST(kg)	LADEFLÄCHE (mm)	AUFHÄNGUNG	RÄDER	BODEN
MODÈLE	PTAC (kg)	CAPACITÉ DE CHARGE(kg)	DIMENSIONS INTÉRIEURES (mm)	SUSPENSION	ROUES	PLANCHER
MODEL	DMC (kg)	ŁADOWNOŚĆ(kg)	POWIERZCHNIA ŁADUNKOWA (mm)	ZAWIESZENIE	KOŁA	PODŁOGA
BUILDER 3 2615 S	1600 - 2700	2166	2600 x 1530 x 250	2 x 1350 kg	195/50 R13C	P
BUILDER 3 2615 S	1600 - 3000	2435	2600 x 1530 x 250	2 x 1500 kg	195/50 R13C	P
BUILDER 3 3015 S	1600 - 2700	2152	2980 x 1530 x 250	2 x 1350 kg	195/50 R13C	P
BUILDER 3 3015 S	1600 - 3000	2436	2980 x 1530 x 250	2 x 1500 kg	195/50 R13C	P
BUILDER 3 3015 S	2700 - 3500	2878	2980 x 1530 x 250	2 x 1800 kg	195/50 R13C	P
BUILDER 3 3516 S	1600 - 2700	2115	3500 x 1680 x 250	2 x 1350 kg	195/50 R13C	P
BUILDER-3 3516 S	1600 - 3000	2397	3500 x 1680 x 250	2 x 1500 kg	195/50 R13C	P
BUILDER 3 3516 S	2700 - 3500	2841	3500 x 1680 x 250	2 x 1800 kg	195/50 R13C	P
BUILDER 3 3516/3 S	2700 - 3500	2814	3500 x 1680 x 250	3 x 1350 kg	195/50 R13C	P
BUILDER 3 4018 S	1600 - 2700	2091	4000 x 1830 x 250	2 x 1350 kg	195/50 R13C	P
BUILDER 3 4018 S	1600 - 3000	2371	4000 x 1830 x 250	2 x 1500 kg	195/50 R13C	P
BUILDER 3 4018 S	1600 - 3500	2794	4000 x 1830 x 250	2 x 1800 kg	195/50 R13C	P
BUILDER 3 4018/3 S	2700 - 3500	2768	4000 x 1830 x 250	3 x 1350 kg	195/50 R13C	P



2 braked axles
2 Achse gebremst
2 essieux freinés
2 osie hamowane



3 braked axles
3 Achse gebremst
3 essieux freinés
3 osie hamowane

[P] - PLYWOOD / SIEBDRUCK
BOIS / SKLEJKA

Dear all! Thank you for your interest in our products. We make every effort to ensure that the information contained in this catalogue is up-to-date and accurate. We would like to inform you that due to the continuous improvement of our products, we are not responsible for the content of the catalogue and the information contained therein is not binding, and their nature is only informative, they do not constitute an offer within the meaning of civil law. This catalogue does not contain any promise or guarantee, also regarding the updating, correction, supplementation and quality of the information. All information contained in this catalogue, as well as the described products and services may be changed or updated by Temared Sp. z o.o. The "TEMARED" trademark, as well as its products, logos, symbols and slogans are the property of Temared Sp. z o.o. Unauthorized use of these trademarks is strictly prohibited.

Sehr geehrte Damen und Herren! Herzlichen Dank für Ihr Interesse an unseren Produkten. Wir bemühen uns unsererseits, dass die in diesem Katalog enthaltenen Informationen aktuell und korrekt sind. Wir möchten Sie darauf hinweisen, dass wir aufgrund der ständigen Verbesserung unserer Produkte keine Verantwortung für den Inhalt des Katalogs übernehmen und die darin enthaltenen Informationen unverbindlich sind, rein informativen Charakter haben und kein Angebot im Sinne des Zivilrechts darstellen. Dieser Katalog enthält keinerlei Versprechungen oder Garantien, auch nicht hinsichtlich der Aktualität, Korrektheit, Ergänzung und Qualität der Informationen. Alle in diesem Katalog enthaltenen Informationen sowie die beschriebenen Produkte und Dienstleistungen können von Temared Sp. z o.o. ohne vorherige Ankündigung geändert oder aktualisiert werden. Die Marke "TEMARED" sowie ihre Produkte, Logos, Symbole und Slogans sind Eigentum der Temared Sp. z o.o. Die unberechtigte Verwendung dieser Marken ist strengstens untersagt.

Mesdames et Messieurs, nous remercions de votre intérêt pour nos produits. Toutes les informations de ce catalogue ont été élaborées sur la base des meilleures informations disponibles et contrôlées avec le plus grand soin. Cependant il n'est pas possible d'exclure toute erreur liée aux modifications de nos produits que nous nous appliquons constamment à corriger ou modifier. C'est pourquoi les données proposées n'impliquent aucune obligation, garantie ni explicite ni implicite particulièrement quant à la nature, la commercialisation, l'aptitude pour les applications prévues. Nous nous réservons le droit de réaliser des modifications ou changements sans notification préalable. TEMARED SP Z O.O. a le droit d'exécuter les changements décrits ci-dessus aux informations, aux produits et aux services à tout moment. Les photos incluses dans ce catalogue appartiennent exclusivement à TEMARED SP Z O.O. TEMARED SP Z O.O. détient l'ensemble des droits de propriété de logo, de la marque de TEMARED, de ses symboles, noms commerciaux et slogans. Il est interdit d'utiliser le logo ou la marque de TEMARED.

Szanowni Państwo! Bardzo dziękujemy za zainteresowanie naszymi produktami. Ze swojej strony dokładamy wszelkich starań aby zapewnić aktualność i dokładność informacji zawartych w tym katalogu. Pragniemy poinformować, że ze względu na ciągłe udoskonalenie produktów nie ponosimy odpowiedzialności w związku z treścią katalogu i informacje w nim zawarte nie są wiążące, a ich charakter jest wyłącznie informacyjny, nie stanowią one oferty w rozumieniu prawa cywilnego. Niniejszy katalog nie zawiera żadnego przyrzeczenia lub gwarancji, także odnośnie aktualizacji, korekcy, uzupełnienia i jakości informacji. Wszystkie informacje zawarte w tym katalogu, jak również opisane produkty i usługi mogą być bez wcześniejszego zawiadomienia zmieniane lub aktualizowane przez Temared Sp. z o.o. Znak towarowy „TEMARED”, a także jej produkty, logo, symbole i slogany są własnością Temared Sp. z o.o. Nieuprawnione używanie tych znaków towarowych jest surowo zabronione.



BOX 3015/2



PURPOSE: Box trailer for the carriage of load requiring special protection, unbraked and braked versions.

COMFORT: side supports; rear door blocker as standard

SECURITY: waterproof sides and doors; in braked versions shock absorbers available as option

CONVIENIENCE: load handles inside, double doors (standard version) or ramp (optional)

CONSTRUCTION: robust, bolted frame.



BESTIMMUNG: Koffernhänger für den Transport, der besonderen Sicherung braucht, ungebremst und gebremst

BENUTZERFREUNDLICHKEIT: Seitenstützen und Türgriffe als Standard

SICHERHEIT: wasserdichte Wände und Türen; Stoßdämpfer erhältlich für gebremste Versionen

PRAKTIKABILITÄT: innerhalb Zurrbügel zur Ladungssicherung, geteilte Türen (Standard) oder Rampe (Option)

KONSTRUKTION: stabiler, geschraubter Rahmen



UTILISATION: remorque fourgon pour le transport des marchandises nécessitant une protection spéciale, versions non freinée et freinée

COMFORT: béquilles latérales en série, supports de portes

SÉCURITÉ: murs et portes étanches, les amortisseurs disponibles en versions freinées

COMMODITÉS: anneau d'ancrage, porte divisée (en série), hayon (en option)

CONSTRUCTION: châssis boulonné stable



PRZEZNACZENIE: przyczepa typu furgon do przewozu ładunku wymagającego szczególnego zabezpieczenia, wersje niehamowane i hamowane

WYGODA: w standardzie podpory boczne; chwytaki drzwi

BEZPIECZEŃSTWO: wodoszczelne ściany i drzwi; w wersjach hamowanych dostępne amortyzatory

UDOGODNIENIA: uchwyty ładunku wewnątrz, drzwi dzielone (standard) lub rampa (opcja)

KONSTRUKCJA: stabilna rama skręciana

BOX 2512 C



- robust bolted construction,
- robuste geschraubte Konstruktion,
- construction boulonnée solide,
- solidna skręciana konstrukcja



BOX 2512 C

- stable hinges, specialized door seals
- robuste Scharniere, spezielle Türdichtungen
- charnières solides, jointes de porte
- stabilne zawiasy, specjalistyczne uszczelki drzwi



- aesthetic and durable plastic mudguards
- ästhetisch und langlebige Kunststoff-Kotflügel
- garde-boues en plastique esthétiques et durables
- estetyczne i wytrzymałe błotniki z tworzywa



BOX 2512 C





BOX 3015/2

- rear door blockaders in open position
- Türgriffe mit Verriegelung in geöffneter Stellung
- poignées verrouillant la porte ouverte
- chwytki blokujące drzwi w pozycji otwartej

- multiple load securing options
- viele Möglichkeiten der Ladungssicherung
- de nombreuses options pour sécuriser la marchandise transportée
- wiele możliwości zamocowania ładunku



BOX 3015/2



BOX 3015/2

BOX

- side supports as standard
- Seitenstützen als Standard
- béquilles latérales en série
- podpory boczne w standardzie

BOX 3015 C



- available in two colors: white or grey (exchangable accoring to plywood availability); Sides made of waterproof plywood covered with melamine.
- austauschbar in weiß und grau erhältlich; Wände aus wasserfestem melaminharzbeschichteten Siebdruck
- disponible en verison blanche ou grise ; murs en contreplaqué imperméable recouvert de mélamine
- dostępne zamiennie w kolorze białym i szarym; ściany z wodoodpornej sklejki pokrytej melaminą

- loading ramp (optional)
- Auffahrrampe (Option)
- hayon (en option)
- rampa najazdowa (opcja)



BOX 3015 C



1 spare wheel, Ersatzrad,
roue de secours, koło zapasowe



2 shock absorbers,
Achsstoßdämpfer,
amortisseurs,
amortyzatory



3 prop stands, Seitenstützen,
béquilles latérales, podpory boczne

4 loading ramp,
Auffahrrampe,
hayon,
rampa najazdowa



5 standard jockey wheel,
Standardstützrad,
roue jockey standard,
manualne koło podporowe













6 automatic jockey wheel,
Automatikstützrad,
roue jockey automatique,
koło podporowe automatyczne



	1	2	3	4	5	6
BOX 2512, 2512/2	<input type="checkbox"/>	-	■	<input type="checkbox"/>	■	-
BOX 2512C, 2512C/2	<input type="checkbox"/>	<input type="checkbox"/>	■	<input type="checkbox"/>	■	-
BOX 3015, 3015/2	<input type="checkbox"/>	<input type="checkbox"/>	■	<input type="checkbox"/>	■	-
BOX 3015C, 3015/2C	<input type="checkbox"/>	<input type="checkbox"/>	■	<input type="checkbox"/>	■	<input type="checkbox"/>

■ standard □ option - unavailable

MODEL	GVWR(kg)	LOAD CAPACITY(kg)	INTERNAL DIMENSIONS (mm)	SUSPENSION	WHEELS	FLOOR	
MODELL	zGG (kg)	NUTZLAST(kg)	LADEFLÄCHE (mm)	AUFHÄNGUNG	RÄDER	BODEN	
MODÈLE	PTAC (kg)	CAPACITÉ DE CHARGE(kg)	DIMENSIONS INTÉRIEURES (mm)	SUSPENSION	ROUES	PLANCHER	
MODEL	DMC (kg)	ŁADOWNOŚĆ(kg)	POWIERZCHNIA ŁADUNKOWA (mm)	ZAWIESZENIE	KOŁA	PODŁOGA	
BOX 2512	750	375	2500 x 1250 x 1490		1 x 750 kg	155/70 R13	P
BOX 2512/2	750	333	2500 x 1250 x 1490		2 x 750 kg	155/70 R13	P
BOX 2512 C	1300	865	2500 x 1250 x 1490		1 x 1350 kg	165 R13C	P
BOX 2512 C	1500	1054	2500 x 1250 x 1490		1 x 1500 kg	195/50 R13C	P
BOX 2512/2 C	2000	1513	2500 x 1250 x 1490		2 x 1000 kg	165 R13C	P
BOX 3015	750	294	3000 x 1476 x 1800		1 x 750 kg	155/70 R13	P
BOX 3015/2	750	252	3000 x 1476 x 1800		2 x 750 kg	155/70 R13	P
BOX 3015 C	1300	740	3000 x 1476 x 1800		1 x 1350 kg	185 R14C	P
BOX 3015 C	1500	930	3000 x 1476 x 1800		1 x 1500 kg	165 R13C	P
BOX 3015/2 C	1500	928	3000 x 1476 x 1800		2 x 750 kg	165/70 R13C	P
BOX 3015/2 C	2000	1360	3000 x 1476 x 1800		2 x 1000 kg	165 R13C	P



1 non-braked axle
1 Achse ungebremst
1 essieu non freiné
1 oś niehamowana



2 non-braked axles
2 ungebremste Achsen
2 essieux non freinés
2 niehamowane osie



1 braked axle
1 Achse gebremst
1 essieu freiné
1 oś hamowana



2 braked axles
2 Achse gebremst
2 essieux freinés
2 osie hamowane

[P] - PLYWOOD / SIEBDRUCK
 BOIS / SKLEJKA

Dear all! Thank you for your interest in our products. We make every effort to ensure that the information contained in this catalogue is up-to-date and accurate. We would like to inform you that due to the continuous improvement of our products, we are not responsible for the content of the catalogue and the information contained therein is not binding, and their nature is only informative, they do not constitute an offer within the meaning of civil law. This catalogue does not contain any promise or guarantee, also regarding the updating, correction, supplementation and quality of the information. All information contained in this catalogue, as well as the described products and services may be changed or updated by Temared Sp. z o.o. The "TEMARED" trademark, as well as its products, logos, symbols and slogans are the property of Temared Sp. z o.o. Unauthorized use of these trademarks is strictly prohibited.

Sehr geehrte Damen und Herren! Herzlichen Dank für Ihr Interesse an unseren Produkten. Wir bemühen uns unsererseits, dass die in diesem Katalog enthaltenen Informationen aktuell und korrekt sind. Wir möchten Sie darauf hinweisen, dass wir aufgrund der ständigen Verbesserung unserer Produkte keine Verantwortung für den Inhalt des Katalogs übernehmen und die darin enthaltenen Informationen unverbindlich sind, rein informativen Charakter haben und kein Angebot im Sinne des Zivilrechts darstellen. Dieser Katalog enthält keinerlei Versprechungen oder Garantien, auch nicht hinsichtlich der Aktualität, Korrektheit, Ergänzung und Qualität der Informationen. Alle in diesem Katalog enthaltenen Informationen sowie die beschriebenen Produkte und Dienstleistungen können von Temared Sp. z o.o. ohne vorherige Ankündigung geändert oder aktualisiert werden. Die Marke "TEMARED" sowie ihre Produkte, Logos, Symbole und Slogans sind Eigentum der Temared Sp. z o.o. Die unberechtigte Verwendung dieser Marken ist strengstens untersagt.

Mesdames et Messieurs, nous remercions de votre intérêt pour nos produits. Toutes les informations de ce catalogue ont été élaborées sur la base des meilleures informations disponibles et contrôlées avec le plus grand soin. Cependant il n'est pas possible d'exclure toute erreur liée aux modifications de nos produits que nous nous appliquons constamment à corriger ou modifier. C'est pourquoi les données proposées n'impliquent aucune obligation, garantie ni explicite ni implicite particulièrement quant à la nature, la commercialisation, l'aptitude pour les applications prévues. Nous nous réservons le droit de réaliser des modifications ou changements sans notification préalable. TEMARED SP Z O.O. a le droit d'exécuter les changements décrits ci-dessus aux informations, aux produits et aux services à tout moment. Les photos incluses dans ce catalogue appartiennent exclusivement à TEMARED SP Z O.O. TEMARED SP Z O.O. détient l'ensemble des droits de propriété de logo, de la marque de TEMARED, de ses symboles, noms commerciaux et slogans. Il est interdit d'utiliser le logo ou la marque de TEMARED.

Szanowni Państwo! Bardzo dziękujemy za zainteresowanie naszymi produktami. Ze swojej strony dokładamy wszelkich starań aby zapewnić aktualność i dokładność informacji zawartych w tym katalogu. Pragniemy poinformować, że ze względu na ciągłe udoskonalenie produktów nie ponosimy odpowiedzialności w związku z treścią katalogu i informacje w nim zawarte nie są wiążące, a ich charakter jest wyłącznie informacyjny, nie stanowią one oferty w rozumieniu prawa cywilnego. Niniejszy katalog nie zawiera żadnego przyrzeczenia lub gwarancji, także odnośnie aktualizacji, korekcji, uzupełnienia i jakości informacji. Wszystkie informacje zawarte w tym katalogu, jak również opisane produkty i usługi mogą być bez wcześniejszego zawiadomienia zmieniane lub aktualizowane przez Temared Sp. z o.o. Znak towarowy „TEMARED”, a także jej produkty, logo, symbole i slogany są własnością Temared Sp. z o.o. Nieuprawnione używanie tych znaków towarowych jest surowo zabronione.



PRO 2612



PURPOSE: series of non-tilting and tilting general duty trailers has many use options for professionals

COMFORT: front and rear sides openable, each trailer has a tilting version

SAFETY: cargo tie down points as standard

CONVIENIENCE: very wide range of options

CONSTRUCTION: solid bolted frame (welded in PRAKTI DUMPER), frame rigidity due to stable crossbars



ZWECK: Die Serie von nicht kippbaren und kippbaren kleine Tiefladern für zahlreiche professionelle Anwendungen

KOMFORT: Vordere und hintere Bordwände offen, jeder Anhänger hat eine kippbare Version

SICHERHEIT: Ladungssicherungspunkte als Standard

PRAKTIKABILITÄT: eine breite Palette von Optionen

KONSTRUKTION: Stabiler geschraubter Rahmen (beim PRAKTI DUMPER geschweißt), steifer Rahmen dank stabiler Traversen



UTILISATION: séries de remorques bagagères non basculantes et basculantes conçues pour diverses tâches pour les professionnels

COMFORT: ridelles avant et arrière ouvrables, chaque remorque a une version basculante

SÉCURITÉ: points d'attache des sangles en série

COMMODITÉS: gamme très large d'options

CONSTRUCTION: châssis solide boulonné (soudé sur PRAKTI DUMPER), la rigidité du châssis grâce à des traverses stables



PRZEZNACZENIE: serie przyczep bagażowych nieuchylnych i uchylnych do wielu zastosowań dla profesjonalistów

WYGODA: przednia i tylna burta otwierane, każda przyczepa posiada wersję uchylną

BEZPIECZEŃSTWO: punkty mocowań ładunku w standardzie

UDOGODNIENIA: bardzo szeroka gama opcji

KONSTRUKCJA: solidna rama skręcana (w PRAKTI DUMPER spawana), sztywność ramy dzięki stabilnym poprzeczkom

- stable sides 40 cm as standard
- stabile Bordwand 40 cm als Standard
- ridelle stable 40cm en série
- stabilna burta 40 cm w standardzie



PRO 2012

- centrally mounted jockey wheel as standard
- mittig montiertes Stützrad als Standard
- roue jockey de série
- w standardzie koło podporowe montowane centralnie



PRO 2012

- sides bis 40 cm (optional)
- Stahlaufsatz 40 cm (Option)
- réhausse de ridelles 40cm (option)
- burty bis 40 cm (opcja)

- composite lamps protected against damage and mud by a rear panel
- Rückleuchten, die durch einen Lichtbalken vor Beschädigung und Schlamm geschützt sind
- lampes multifonction protégées des dommages et de la boue par une barre d'éclairage arrière
- lampy zespolone chronione przed uszkodzeniami i błotem przez belkę oświetleniową

PRO 3015/2

- cargo tie down points in the corners of the loading area
- Ladungssicherungspunkte in den Ecken der Ladefläche
- anneaux d'arrimage dans les coins du plancher
- punkty mocowania ładunku w narożnikach powierzchni ładunkowej



- different trailer lengths to suit different transport needs
- verschiedene Anhängerlängen für unterschiedliche Transportbedürfnisse
- différentes longueurs de remorques adaptées aux différents besoins des utilisateurs
- różne długości przyczep dopasowane do różnych potrzeb transportowych

PRO 2012



PRO 2312



PRO 2612



PRO 2612/2



- stable fixed drawbar
- speziell verstärkte Deichsel
- timon fixe stable
- stabilny stały dyszel

PRO 3015



PRO 3015/2



PRO BRAKE 3015/2



- reinforcement of sides (standard in PRO BRAKE)
- Boardwändeverstärkungen (serienmäßig bei PRO BRAKE)
- renforts de ridelles (de série sur PRO BRAKE)
- wzmocnienia brt (standard w PRO BRAKE)

- front and rear sides openable
- die vorderen und hinterenwände können geöffnet werden
- ridelles avant et arrière ouvrables
- przednia i tylna burta otwierane

PRO BRAKE 3015/2

- floor made of waterproof, non-slip plywood 12mm
- Boden aus wasserfestem, rutschfestem 12mm Siebdruck
- plancher en contreplaqué imperméable et antidérapant de 12 mm
- podłoga z wodoodpornej sklejki 12mm

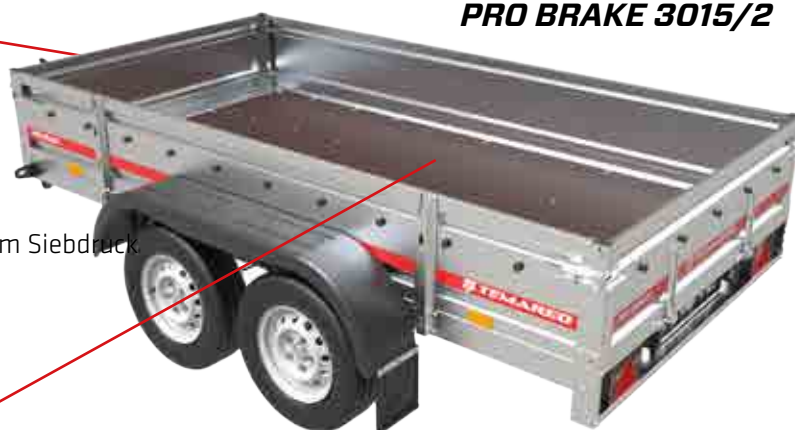

- special reinforced drawbar
- speziell verstärkte Deichsel
- timon spécial renforcé
- specjalny wzmocniony dyszel



PRAKTI 2612



- practical tilting drawbar (standard in PRAKTI)
- praktische Kippdeichsel (Standard bei PRAKTI)
- tiimon basculant pratique (de série sur PRAKTI)
- praktyczny uchylny dyszel (standard w PRAKTI)



PRAKTI 2012



PRAKTI 2012

- tilting trailer makes easier loading of vehicles
- kippbarer Anhänger, leichteres Beladen von Fahrzeugen
- remorque basculante, le chargement plus facile des véhicules
- przyczepa uchylna, ułatwiony załadunek pojazdów

**PRO, PRO BREAK, PRAKTI,
PRAKTI DUMPER, WOOD**

TEMARED
all about trailers

PRAKTI 2612



- optional tarpaulin with cover H1100 that rises the loading area by 110 cm
- die H1100 Hochplane erhöht den Laderaum um 110 cm
- bâche H1100 qui surélève la zone de chargement de 110 cm
- akcesoryjny pokrowiec ze stelażem H110 powiększa przestrzeń ładunkową o 110cm.

PRAKTI 2615/2





PRAKTI DUMPER 2314

- easy-to-use manual tilting mechanism including braked winch
- praktischer Hebewerk mit sicherer Winde mit Lastdruckbremse
- mécanisme de soulèvement manuel facile à utiliser, compris treuil freiné
- praktyczny mechanizm uchyty z bezpieczną, hamowaną wciągarką linową

PRAKTI DUMPER 2314

- side supports as standard
- Stützrad als Standard
- béquilles latérales de série
- podpory boczne w standardzie

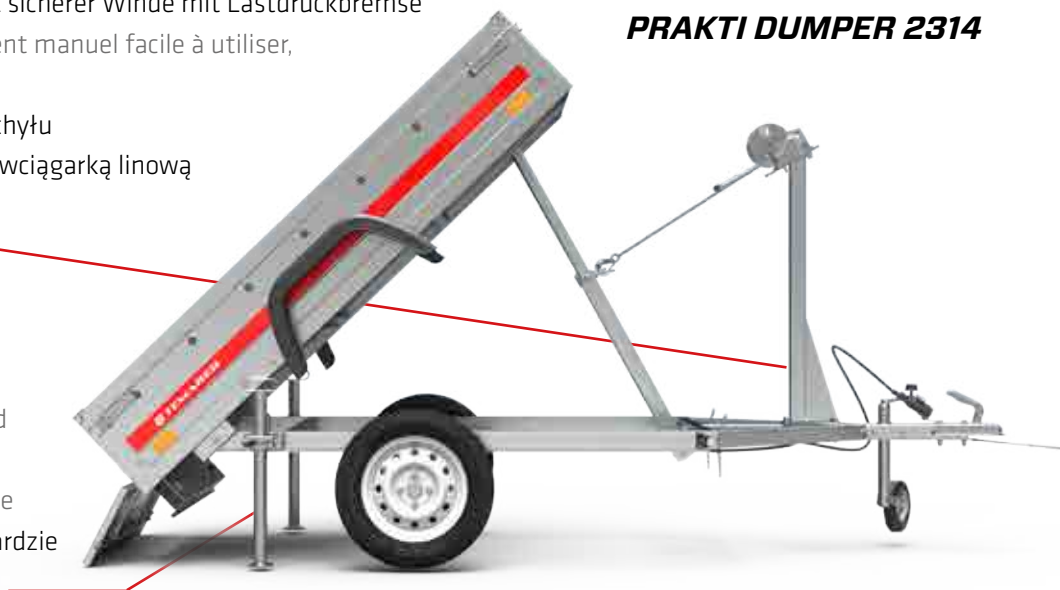

- floor made of waterproof, non-slip plywood 9mm
- Boden aus wasserfestem, rutschfestem 9mm Siebdruck
- plancher en contreplaqué imperméable et antidérapant de 9mm
- podłoga z wodoodpornej sklejki 9mm

PRAKTI DUMPER 2314



- jockey wheel as standard
- Stützrad als Standard
- roue jockey de série
- koło podporowe w standardzie

PRAKTI DUMPER 2314



- upper and lower frame stable, welded
- oberer und unterer Rahmen stabil, geschweißt
- upper and lower frame stable, welded
- stabilne spawane ramy górna/dolna

WOOD 2012 KIPP



- you can choose a version with a fixed or tilting drawbar
- optionale Version mit fester oder klappbarer Deichsel
- version avec le timon fixe ou inclinable à choisir
- do wyboru wersja z dyszlem stłym lub uchylnym

- plywood sides reinforced with a stable frame
- Siebdruckboardwand mit stabilem Rahmen verstärkt
- ridelles en contreplaqué renforcées par un châssis stable
- burty ze sklejkki wzmocnione stabilną ramą

WOOD 2612/2 KIPP



- integrated railings around the perimeter
- integrierte Reling um den gesamten Umfang
- mains courantes intégrées autour du périmètre
- zintegrowane relingi na całym obwodzie

- composite lamps protected against damage and mud by a rear panel
- Rückleuchten, die durch einen Lichtbalken vor Beschädigung und Schlamm geschützt sind
- lampes multifonction protégées des dommages et de la boue par une barre d'éclairage arrière
- lampy zespolone chronione przed uszkodzeniami i błotem przez belkę oświetleniową



WOOD 2012 KIPP













































WOOD 2012 KIPP





































- exceptional rigidity of the frame and sides
- außergewöhnliche Steifigkeit des Rahmens und der Bordwände
- rigidité exceptionnelle du châssis et des ridelles
- wyjątkowa sztywność ramy i burt

- drive-on possibility due to plywood sides
- Zugänglichkeit des Fahrzeugs durch Siebruckboardwände
- entrée par le véhicule possible grâce aux ridelles en contreplaqué
- możliwość najazdu pojazdem dzięki burtom ze sklejki

WOOD 2012 KIPP



MODEL	GVWR (kg)	LOAD CAPACITY(kg)	INTERNAL DIMENSIONS (mm)	SUSPENSION	BRAKES	TILTING	WHEELS
MODELL	zGG (kg)	NUTZLAST(kg)	LADEFLÄCHE (mm)	AUFHÄNGUNG	BREMSE	KIPPBAR	RÄDER
MODÈLE	PTAC (kg)	CAPACITÉ DE CHARGE(kg)	DIMENSIONS INTÉRIEURES (mm)	SUSPENSION	FREINS	BASCULANT	ROUES
MODEL	DMC (kg)	ŁADOWNOŚĆ(kg)	POWIERZCHNIA ŁADUNKOWA (mm)	ZAWIESZENIE	HAMULCE	UCHYLNNA	KOŁA
PRO 2012	300-750	596	2010 x 1260 x 400	 1x750 kg	-	-	155/70 R13
PRO 2012/R	300-750	570	2010 x 1260 x 400	 1x750 kg	-	-	155/70 R13
PRO 2312	300-750	586	2305 x 1260 x 400	 1x750 kg	-	-	155/70 R13
PRO 2312/R	300-750	560	2305 x 1260 x 400	 1x750 kg	-	-	155/70 R13
PRO 2312/2	300-750	536	2305 x 1260 x 400	 2x750 kg	-	-	155/70 R13
PRO 2612	300-750	574	2640 x 1260 x 400	 1x750 kg	-	-	155/70 R13
PRO 2612/R	300-750	548	2640 x 1260 x 400	 1x750 kg	-	-	155/70 R13
PRO 2612/2	300-750	524	2640 x 1260 x 400	 2x750 kg	-	-	155/70 R13
PRO 2615	300-750	552	2640 x 1500 x 400	 1x750 kg	-	-	155/70 R13
PRO 2615/R	300-750	526	2640 x 1500 x 400	 1x750 kg	-	-	155/70 R13
PRO 2615/2	300-750	502	2640 x 1500 x 400	 2x750 kg	-	-	155/70 R13
PRO 3015	300-750	523	2960 x 1500 x 400	 1x750 kg	-	-	155/70 R13
PRO 3015/R	300-750	497	2960 x 1500 x 400	 1x750 kg	-	-	155/70 R13
PRO 3015/2	300-750	473	2960 x 1500 x 400	 2x750 kg	-	-	155/70 R13
PRO 3515	300-750	504	3460 x 1500 x 300	 1x750 kg	-	-	155/70 R13
PRO 3515/R	300-750	478	3460 x 1500 x 300	 1x750 kg	-	-	155/70 R13
PRO 3515/2	300-750	458	3460 x 1500 x 300	 2x750 kg	-	-	155/70 R13
PRO BRAKE 2012 C	750	574	2010 x 1260 x 400	 1x750 kg	+	-	155/70 R13
PRO BRAKE 2012 C	800 - 1000	807	2010 x 1260 x 400	 1x1000 kg	+	-	165 R13C
PRO BRAKE 2012 C	800 - 1300	1099	2010 x 1260 x 400	 1x1350 kg	+	-	165 R13C
PRO BRAKE 2012 C	800 - 1500	1285	2010 x 1260 x 400	 1x1500 kg	+	-	195/50R13C
PRO BRAKE 2312 C	750	539	2400 x 1260 x 400	 1x750 kg	+	-	155/70 R13
PRO BRAKE 2312 C	800 - 1000	772	2400 x 1260 x 400	 1x1000 kg	+	-	165 R13C
PRO BRAKE 2312 C	800 - 1300	1064	2400 x 1260 x 400	 1x1350 kg	+	-	165 R13C
PRO BRAKE 2312 C	800 - 1500	1250	2400 x 1260 x 400	 1x1500 kg	+	-	195/50R13C
PRO BRAKE 2612 C	750	550	2640 x 1260 x 400	 1x750 kg	+	-	155/70 R13
PRO BRAKE 2612 C	800 - 1000	781	2640 x 1260 x 400	 1x1000 kg	+	-	165 R13C
PRO BRAKE 2612 C	800 - 1300	1028	2640 x 1260 x 400	 1x1350 kg	+	-	165 R13C
PRO BRAKE 2612 C	800 - 1500	1222	2640 x 1260 x 400	 1x1500 kg	+	-	195/50R13C
PRO BRAKE 2612/2 C	800 - 1500	1198	2640 x 1260 x 400	 2x750 kg	+	-	155/70R13
PRO BRAKE 2612/2 C	1000 - 2000	1658	2640 x 1260 x 400	 2x1000 kg	+	-	165 R13C
PRO BRAKE 2615 C	750	512	2640 x 1500 x 400	 1x750 kg	+	-	155/70 R13
PRO BRAKE 2615 C	800 - 1000	742	2640 x 1500 x 400	 1x1000 kg	+	-	165 R13C
PRO BRAKE 2615 C	800 - 1300	1028	2640 x 1500 x 400	 1x1350 kg	+	-	165 R13C
PRO BRAKE 2615 C	800 - 1500	1221	2640 x 1500 x 400	 1x1500 kg	+	-	195/50R13C
PRO BRAKE 2615/2 C	800 - 1500	1205	2640 x 1500 x 400	 2x750 kg	+	-	155/70R13
PRO BRAKE 2615/2 C	1000 - 2000	1658	2640 x 1500 x 400	 2x1000 kg	+	-	165 R13C
PRO BRAKE 3015 C	750	492	2960 x 1500 x 400	 1x750 kg	+	-	155/70 R13
PRO BRAKE 3015 C	800 - 1000	722	2960 x 1500 x 400	 1x1000 kg	+	-	165 R13C
PRO BRAKE 3015 C	800 - 1300	1008	2960 x 1500 x 400	 1x1350 kg	+	-	165 R13C
PRO BRAKE 3015 C	800 - 1500	1164	2960 x 1500 x 400	 1x1500 kg	+	-	195/50R13C
PRO BRAKE 3015/2 C	800 - 1500	1180	2960 x 1500 x 400	 2x750 kg	+	-	155/70R13
PRO BRAKE 3015/2 C	1000 - 2000	1622	2960 x 1500 x 400	 2x1000 kg	+	-	165 R13C

MODEL	GVWR (kg)	LOAD CAPACITY(kg)	INTERNAL DIMENSIONS (mm)	SUSPENSION	BRAKES	TILTING	WHEELS
MODELL	zGG (kg)	NUTZLAST(kg)	LADEFLÄCHE (mm)	AUFHÄNGUNG	BREMSE	KIPPBAR	RÄDER
MODÈLE	PTAC (kg)	CAPACITÉ DE CHARGE(kg)	DIMENSIONS INTÉRIEURES (mm)	SUSPENSION	FREINS	BASCULANT	ROUES
MODEL	DMC (kg)	ŁADOWNOŚĆ(kg)	POWIERZCHNIA ŁADUNKOWA (mm)	ZAWIESZENIE	HAMULCE	UCHYLNA	KOŁA
PRAKTI 2012	300 - 750	582	2010 x 1260 x 400	 1x750 kg	-	+	155/70 R13
PRAKTI 2012/R	300 - 750	556	2010 x 1260 x 400	 1x750 kg	-	+	155/70 R13
PRAKTI 2312	300 - 750	570	2305 x 1260 x 400	 1x750 kg	-	+	155/70 R13
PRAKTI 2312/R	300 - 750	544	2305 x 1260 x 400	 1x750 kg	-	+	155/70 R13
PRAKTI 2312/2	300 - 750	520	2305 x 1260 x 400	 2x750 kg	-	+	155/70 R13
PRAKTI 2612	300 - 750	556	2640 x 1260 x 400	 1x750 kg	-	+	155/70 R13
PRAKTI 2612/R	300 - 750	530	2640 x 1260 x 400	 1x750 kg	-	+	155/70 R13
PRAKTI 2612/2	300 - 750	506	2640 x 1260 x 400	 2x750 kg	-	+	155/70 R13
PRAKTI 2615	300 - 750	552	2640 x 1500 x 400	 1x750 kg	-	+	155/70 R13
PRAKTI 2615/R	300 - 750	528	2640 x 1500 x 400	 1x750 kg	-	+	155/70 R13
PRAKTI 2615/2	300 - 750	502	2640 x 1500 x 400	 2x750 kg	-	+	155/70 R13
PRAKTI 3015	300 - 750	532	2960 x 1500 x 400	 1x750 kg	-	+	155/70 R13
PRAKTI 3015/R	300 - 750	506	2960 x 1500 x 400	 1x750 kg	-	+	155/70 R13
PRAKTI 3015/2	300 - 750	482	2960 x 1500 x 400	 2x750 kg	-	+	155/70 R13
PRAKTI DUMPER 2014	300 - 750	563	2050 x 1350 x 350	 1x750 kg	-	+	155/70 R13
PRAKTI DUMPER 2014R	300 - 750	537	2050 x 1350 x 350	 1x750 kg	-	+	155/70 R13
PRAKTI DUMPER 2314	300 - 750	554	2360 x 1350 x 350	 1x750 kg	-	+	155/70 R13
PRAKTI DUMPER 2314R	300 - 750	528	2360 x 1350 x 350	 1x750 kg	-	+	155/70 R13
PRAKTI DUMPER 2614	300 - 750	530	2360 x 1350 x 350	 1x750 kg	-	+	155/70 R13
PRAKTI DUMPER 2614R	300 - 750	504	2360 x 1350 x 350	 1x750 kg	-	+	155/70 R13
PRAKTI DUMPER 2614/2	300 - 750	490	2630 x 1350 x 350	 1x750 kg	-	+	155/70 R13
WOOD 2012	300 - 750	577	2010 x 1260 x 400	 1x750 kg	-	-	155/70 R13
WOOD 2012/R	300 - 750	551	2010 x 1260 x 400	 1x750 kg	-	-	155/70 R13
WOOD 2012 KIPP	300 - 750	564	2010 x 1260 x 400	 1x750 kg	-	+	155/70 R13
WOOD 2012/R KIPP	300 - 750	538	2010 x 1260 x 400	 1x750 kg	-	+	155/70 R13
WOOD 2312	300 - 750	558	2305 x 1260 x 400	 1x750 kg	-	-	155/70 R13
WOOD 2312/R	300 - 750	532	2305 x 1260 x 400	 2x750 kg	-	-	155/70 R13
WOOD 2312/2	300 - 750	508	2305 x 1260 x 400	 2x1000 kg	-	-	155/70 R13
WOOD 2312 KIPP	300 - 750	559	2305 x 1260 x 400	 1x750 kg	-	+	155/70 R13
WOOD 2312/R KIPP	300 - 750	533	2305 x 1260 x 400	 1x750 kg	-	+	155/70 R13
WOOD 2312/2 KIPP	300 - 750	509	2305 x 1260 x 400	 1x750 kg	-	+	155/70 R13
WOOD 2612	300 - 750	555	2640 x 1260 x 400	 1x750 kg	-	-	155/70 R13
WOOD 2612/R	300 - 750	529	2640 x 1260 x 400	 2x750 kg	-	-	155/70 R13
WOOD 2612/2	300 - 750	505	2640 x 1260 x 400	 2x750 kg	-	-	155/70 R13
WOOD 2612 KIPP	300 - 750	544	2640 x 1260 x 400	 1x750 kg	-	+	155/70 R13
WOOD 2612/R KIPP	300 - 750	518	2640 x 1260 x 400	 1x750 kg	-	+	155/70 R13
WOOD 2612/2 KIPP	300 - 750	494	2640 x 1260 x 400	 1x750 kg	-	+	155/70 R13



PRO 2615



1 side reinforcements,
Bordwandverstärkungen,
renforts des ridelles,
wzmocnienia burt



2 flat cover, Flachplane,
bâche plate, pokrowiec płaski



3 cover H800,
Plane H800,
bâche haute H800,
pokrowiec H800



4 cover H1100,
Plane H1100,
bâche haute H1100,
pokrowiec H1100

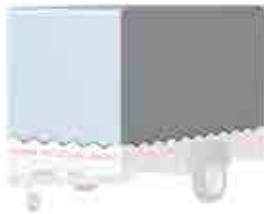

5 cover H1400,
Plane H1400,
bâche haute H1400,
pokrowiec H1400

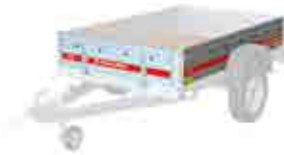

6 alu sides
Alubordwände
ridelles en alu
burty ALU



7 alu extensions,
Alubordwandaufsatz,
réhausses de ridelles en alu,
burty ALU BIS



8 steel extensions,
Stahlbordwandaufsatz,
réhausses de ridelles en acier,
burty BIS stal



9 mesh extensions,
Laubgitteraufsatz,
réhausses de ridelles grillagées,
burty BIS stal siatkowe 40cm



10 alu cover, ALU Deckel,
capot alu, pokrywa ALU



11 standard jockey wheel,
Standardstützrad,
roue jockey standard,
koło podporowe manualne



12 spare wheel, Ersatzrad,
roue de secours,
koło zapasowe



13 shock absorbers,
Achsstoßdämpfer,
amortisseurs,
amortyzatory



14 Front rail bolted / ladder rack,
vordere Reling geschraubt,
Porte échelle avant boulonné,
reling przedni skrecany



15 alu ramps,
Aluauflahrampen,
rampes en alu,
najazdy alu



16 full ramp,
Volle Stahlauffahrrampe,
rampe de chargement,
najazd pełny



17 prop stands,
Seitenstützen,
béquilles latérales,
podpory boczne



18 tipping winch,
Hebewerk,
mécanisme de soulèvement,
mechanizm podnoszenia

19 automatic jockey wheel,
Automatikstützrad,
roue jockey automatique,
koło podporowe automatyczne



	1	2	3	4	5	6	7	8	9	10	11	12	13	14	15	16	17	18	19
PRO 2012	<input type="checkbox"/>	<input type="checkbox"/>	<input type="checkbox"/>	-	-	<input type="checkbox"/>	<input type="checkbox"/>	<input type="checkbox"/>	<input type="checkbox"/>	<input type="checkbox"/>	<input checked="" type="checkbox"/>	<input type="checkbox"/>	-	<input type="checkbox"/>	<input type="checkbox"/>	<input type="checkbox"/>	<input type="checkbox"/>	-	-
PRO 2012/R	<input type="checkbox"/>	<input type="checkbox"/>	<input type="checkbox"/>	-	-	<input type="checkbox"/>	<input type="checkbox"/>	<input type="checkbox"/>	<input type="checkbox"/>	<input type="checkbox"/>	<input checked="" type="checkbox"/>	<input type="checkbox"/>	-	<input type="checkbox"/>	<input type="checkbox"/>	<input type="checkbox"/>	<input type="checkbox"/>	-	-
PRO 2312	<input type="checkbox"/>	<input type="checkbox"/>	<input type="checkbox"/>	<input type="checkbox"/>	-	<input type="checkbox"/>	<input type="checkbox"/>	<input type="checkbox"/>	<input type="checkbox"/>	<input type="checkbox"/>	<input checked="" type="checkbox"/>	<input type="checkbox"/>	-	<input type="checkbox"/>	<input type="checkbox"/>	<input type="checkbox"/>	<input type="checkbox"/>	-	-
PRO 2312/R	<input type="checkbox"/>	<input type="checkbox"/>	<input type="checkbox"/>	<input type="checkbox"/>	-	<input type="checkbox"/>	<input type="checkbox"/>	<input type="checkbox"/>	<input type="checkbox"/>	<input type="checkbox"/>	<input checked="" type="checkbox"/>	<input type="checkbox"/>	-	<input type="checkbox"/>	<input type="checkbox"/>	<input type="checkbox"/>	<input type="checkbox"/>	-	-
PRO 2312/2	<input type="checkbox"/>	<input type="checkbox"/>	<input type="checkbox"/>	<input type="checkbox"/>	-	<input type="checkbox"/>	<input type="checkbox"/>	<input type="checkbox"/>	<input type="checkbox"/>	<input type="checkbox"/>	<input checked="" type="checkbox"/>	<input type="checkbox"/>	-	<input type="checkbox"/>	<input type="checkbox"/>	<input type="checkbox"/>	<input type="checkbox"/>	-	-
PRO 2612	<input type="checkbox"/>	<input type="checkbox"/>	<input type="checkbox"/>	<input type="checkbox"/>	-	<input type="checkbox"/>	<input type="checkbox"/>	<input type="checkbox"/>	<input type="checkbox"/>	<input type="checkbox"/>	<input checked="" type="checkbox"/>	<input type="checkbox"/>	-	<input type="checkbox"/>	<input type="checkbox"/>	<input type="checkbox"/>	<input type="checkbox"/>	-	-
PRO 2612/R	<input type="checkbox"/>	<input type="checkbox"/>	<input type="checkbox"/>	<input type="checkbox"/>	-	<input type="checkbox"/>	<input type="checkbox"/>	<input type="checkbox"/>	<input type="checkbox"/>	<input type="checkbox"/>	<input checked="" type="checkbox"/>	<input type="checkbox"/>	-	<input type="checkbox"/>	<input type="checkbox"/>	<input type="checkbox"/>	<input type="checkbox"/>	-	-
PRO 2612/2	<input type="checkbox"/>	<input type="checkbox"/>	<input type="checkbox"/>	<input type="checkbox"/>	-	<input type="checkbox"/>	<input type="checkbox"/>	<input type="checkbox"/>	<input type="checkbox"/>	<input type="checkbox"/>	<input checked="" type="checkbox"/>	<input type="checkbox"/>	-	<input type="checkbox"/>	<input type="checkbox"/>	<input type="checkbox"/>	<input type="checkbox"/>	-	-
PRO 2615	<input type="checkbox"/>	<input type="checkbox"/>	<input type="checkbox"/>	<input type="checkbox"/>	-	<input type="checkbox"/>	<input type="checkbox"/>	<input type="checkbox"/>	<input type="checkbox"/>	-	<input checked="" type="checkbox"/>	<input type="checkbox"/>	-	<input type="checkbox"/>	<input type="checkbox"/>	<input type="checkbox"/>	<input type="checkbox"/>	-	-
PRO 2615/R	<input type="checkbox"/>	<input type="checkbox"/>	<input type="checkbox"/>	<input type="checkbox"/>	-	<input type="checkbox"/>	<input type="checkbox"/>	<input type="checkbox"/>	<input type="checkbox"/>	-	<input checked="" type="checkbox"/>	<input type="checkbox"/>	-	<input type="checkbox"/>	<input type="checkbox"/>	<input type="checkbox"/>	<input type="checkbox"/>	-	-
PRO 2615/2	<input type="checkbox"/>	<input type="checkbox"/>	<input type="checkbox"/>	<input type="checkbox"/>	-	<input type="checkbox"/>	<input type="checkbox"/>	<input type="checkbox"/>	<input type="checkbox"/>	-	<input checked="" type="checkbox"/>	<input type="checkbox"/>	-	<input type="checkbox"/>	<input type="checkbox"/>	<input type="checkbox"/>	<input type="checkbox"/>	-	-
PRO 3015	<input type="checkbox"/>	<input type="checkbox"/>	-	-	<input type="checkbox"/>	<input type="checkbox"/>	<input type="checkbox"/>	<input type="checkbox"/>	<input type="checkbox"/>	-	<input checked="" type="checkbox"/>	<input type="checkbox"/>	-	<input type="checkbox"/>	<input type="checkbox"/>	<input type="checkbox"/>	<input type="checkbox"/>	-	-
PRO 3015/R	<input type="checkbox"/>	<input type="checkbox"/>	-	-	<input type="checkbox"/>	<input type="checkbox"/>	<input type="checkbox"/>	<input type="checkbox"/>	<input type="checkbox"/>	-	<input checked="" type="checkbox"/>	<input type="checkbox"/>	-	<input type="checkbox"/>	<input type="checkbox"/>	<input type="checkbox"/>	<input type="checkbox"/>	-	-
PRO 3015/2	<input type="checkbox"/>	<input type="checkbox"/>	-	-	<input type="checkbox"/>	<input type="checkbox"/>	<input type="checkbox"/>	<input type="checkbox"/>	<input type="checkbox"/>	-	<input checked="" type="checkbox"/>	<input type="checkbox"/>	-	<input type="checkbox"/>	<input type="checkbox"/>	<input type="checkbox"/>	<input type="checkbox"/>	-	-
PRO 3015 ALU (H300)	<input type="checkbox"/>	<input type="checkbox"/>	-	-	<input type="checkbox"/>	<input checked="" type="checkbox"/>	<input type="checkbox"/>	<input type="checkbox"/>	<input type="checkbox"/>	-	<input checked="" type="checkbox"/>	<input type="checkbox"/>	-	<input type="checkbox"/>	<input type="checkbox"/>	<input type="checkbox"/>	<input type="checkbox"/>	-	-
PRO 3015 ALU/R (H300)	<input type="checkbox"/>	<input type="checkbox"/>	-	-	<input type="checkbox"/>	<input checked="" type="checkbox"/>	<input type="checkbox"/>	<input type="checkbox"/>	<input type="checkbox"/>	-	<input checked="" type="checkbox"/>	<input type="checkbox"/>	-	<input type="checkbox"/>	<input type="checkbox"/>	<input type="checkbox"/>	<input type="checkbox"/>	-	-
PRO 3015 ALU/2 (H300)	<input type="checkbox"/>	<input type="checkbox"/>	-	-	<input type="checkbox"/>	<input checked="" type="checkbox"/>	<input type="checkbox"/>	<input type="checkbox"/>	<input type="checkbox"/>	-	<input checked="" type="checkbox"/>	<input type="checkbox"/>	-	<input type="checkbox"/>	<input type="checkbox"/>	<input type="checkbox"/>	<input type="checkbox"/>	-	-
PRO 3515	<input checked="" type="checkbox"/>	-	-	-	<input type="checkbox"/>	<input checked="" type="checkbox"/>	<input type="checkbox"/>	-	-	-	<input checked="" type="checkbox"/>	<input checked="" type="checkbox"/>	-	<input type="checkbox"/>	<input type="checkbox"/>	<input type="checkbox"/>	<input type="checkbox"/>	-	-
PRO BRAKE 2012 C	<input type="checkbox"/>	<input type="checkbox"/>	<input type="checkbox"/>	-	-	<input type="checkbox"/>	<input type="checkbox"/>	<input type="checkbox"/>	<input type="checkbox"/>	<input type="checkbox"/>	<input checked="" type="checkbox"/>	<input type="checkbox"/>	-	<input type="checkbox"/>	-	-	<input type="checkbox"/>	-	-
PRO BRAKE 2312 C	<input type="checkbox"/>	<input type="checkbox"/>	<input type="checkbox"/>	<input type="checkbox"/>	-	<input type="checkbox"/>	<input type="checkbox"/>	<input type="checkbox"/>	<input type="checkbox"/>	<input type="checkbox"/>	<input checked="" type="checkbox"/>	<input type="checkbox"/>	-	<input type="checkbox"/>	-	-	<input type="checkbox"/>	-	-
PRO BRAKE 2612 C	<input type="checkbox"/>	<input type="checkbox"/>	<input type="checkbox"/>	<input type="checkbox"/>	-	<input type="checkbox"/>	<input type="checkbox"/>	<input type="checkbox"/>	<input type="checkbox"/>	<input type="checkbox"/>	<input checked="" type="checkbox"/>	<input type="checkbox"/>	-	<input type="checkbox"/>	-	-	<input type="checkbox"/>	-	-
PRO BRAKE 2612/2 C	<input type="checkbox"/>	<input type="checkbox"/>	<input type="checkbox"/>	<input type="checkbox"/>	-	<input type="checkbox"/>	<input type="checkbox"/>	<input type="checkbox"/>	<input type="checkbox"/>	<input type="checkbox"/>	<input checked="" type="checkbox"/>	<input type="checkbox"/>	-	<input type="checkbox"/>	-	-	<input type="checkbox"/>	-	-
PRO BRAKE 2615 C	<input type="checkbox"/>	<input type="checkbox"/>	<input type="checkbox"/>	<input type="checkbox"/>	-	<input type="checkbox"/>	<input type="checkbox"/>	<input type="checkbox"/>	<input type="checkbox"/>	-	<input checked="" type="checkbox"/>	<input type="checkbox"/>	-	<input type="checkbox"/>	-	-	<input type="checkbox"/>	-	-
PRO BRAKE 2615/2 C	<input type="checkbox"/>	<input type="checkbox"/>	<input type="checkbox"/>	<input type="checkbox"/>	-	<input type="checkbox"/>	<input type="checkbox"/>	<input type="checkbox"/>	<input type="checkbox"/>	-	<input checked="" type="checkbox"/>	<input type="checkbox"/>	-	<input type="checkbox"/>	-	-	<input type="checkbox"/>	-	-
PRO BRAKE 3015 C	<input type="checkbox"/>	<input type="checkbox"/>	-	-	<input type="checkbox"/>	<input type="checkbox"/>	<input type="checkbox"/>	<input type="checkbox"/>	<input type="checkbox"/>	-	<input checked="" type="checkbox"/>	<input type="checkbox"/>	-	<input type="checkbox"/>	-	-	<input type="checkbox"/>	-	-
PRO BRAKE 3015	<input type="checkbox"/>	<input type="checkbox"/>	-	-	<input type="checkbox"/>	<input type="checkbox"/>	<input type="checkbox"/>	<input type="checkbox"/>	<input type="checkbox"/>	-	<input checked="" type="checkbox"/>	<input type="checkbox"/>	-	<input type="checkbox"/>	-	-	<input type="checkbox"/>	-	-
PRO BRAKE 3015/2 C	<input type="checkbox"/>	<input type="checkbox"/>	-	-	<input type="checkbox"/>	<input type="checkbox"/>	<input type="checkbox"/>	<input type="checkbox"/>	<input type="checkbox"/>	-	<input checked="" type="checkbox"/>	<input type="checkbox"/>	-	<input type="checkbox"/>	-	-	<input type="checkbox"/>	<input type="checkbox"/>	-
PRAKTI 2012	<input type="checkbox"/>	<input type="checkbox"/>	<input type="checkbox"/>	-	-	<input type="checkbox"/>	<input type="checkbox"/>	<input type="checkbox"/>	<input type="checkbox"/>	<input type="checkbox"/>	<input checked="" type="checkbox"/>	<input type="checkbox"/>	-	<input type="checkbox"/>	<input type="checkbox"/>	<input type="checkbox"/>	<input type="checkbox"/>	<input type="checkbox"/>	-
PRAKTI 2012/R	<input type="checkbox"/>	<input type="checkbox"/>	<input type="checkbox"/>	-	-	<input type="checkbox"/>	<input type="checkbox"/>	<input type="checkbox"/>	<input type="checkbox"/>	<input type="checkbox"/>	<input checked="" type="checkbox"/>	<input type="checkbox"/>	-	<input type="checkbox"/>	<input type="checkbox"/>	<input type="checkbox"/>	<input type="checkbox"/>	<input type="checkbox"/>	-
PRAKTI 2312	<input type="checkbox"/>	<input type="checkbox"/>	<input type="checkbox"/>	<input type="checkbox"/>	-	<input type="checkbox"/>	<input type="checkbox"/>	<input type="checkbox"/>	<input type="checkbox"/>	<input type="checkbox"/>	<input checked="" type="checkbox"/>	<input type="checkbox"/>	-	<input type="checkbox"/>	<input type="checkbox"/>	<input type="checkbox"/>	<input type="checkbox"/>	<input type="checkbox"/>	-
PRAKTI 2312/R	<input type="checkbox"/>	<input type="checkbox"/>	<input type="checkbox"/>	<input type="checkbox"/>	-	<input type="checkbox"/>	<input type="checkbox"/>	<input type="checkbox"/>	<input type="checkbox"/>	<input type="checkbox"/>	<input checked="" type="checkbox"/>	<input type="checkbox"/>	-	<input type="checkbox"/>	<input type="checkbox"/>	<input type="checkbox"/>	<input type="checkbox"/>	<input type="checkbox"/>	-
PRAKTI 2312/2	<input type="checkbox"/>	<input type="checkbox"/>	<input type="checkbox"/>	<input type="checkbox"/>	-	<input type="checkbox"/>	<input type="checkbox"/>	<input type="checkbox"/>	<input type="checkbox"/>	<input type="checkbox"/>	<input checked="" type="checkbox"/>	<input type="checkbox"/>	-	<input type="checkbox"/>	<input type="checkbox"/>	<input type="checkbox"/>	<input type="checkbox"/>	<input type="checkbox"/>	-
PRAKTI 2612	<input type="checkbox"/>	<input type="checkbox"/>	<input type="checkbox"/>	<input type="checkbox"/>	-	<input type="checkbox"/>	<input type="checkbox"/>	<input type="checkbox"/>	<input type="checkbox"/>	<input type="checkbox"/>	<input checked="" type="checkbox"/>	<input type="checkbox"/>	-	<input type="checkbox"/>	<input type="checkbox"/>	<input type="checkbox"/>	<input type="checkbox"/>	<input type="checkbox"/>	-
PRAKTI 2612/R	<input type="checkbox"/>	<input type="checkbox"/>	<input type="checkbox"/>	<input type="checkbox"/>	-	<input type="checkbox"/>	<input type="checkbox"/>	<input type="checkbox"/>	<input type="checkbox"/>	<input type="checkbox"/>	<input checked="" type="checkbox"/>	<input type="checkbox"/>	-	<input type="checkbox"/>	<input type="checkbox"/>	<input type="checkbox"/>	<input type="checkbox"/>	<input type="checkbox"/>	-
PRAKTI 2612/2	<input type="checkbox"/>	<input type="checkbox"/>	<input type="checkbox"/>	<input type="checkbox"/>	-	<input type="checkbox"/>	<input type="checkbox"/>	<input type="checkbox"/>	<input type="checkbox"/>	<input type="checkbox"/>	<input checked="" type="checkbox"/>	<input type="checkbox"/>	-	<input type="checkbox"/>	<input type="checkbox"/>	<input type="checkbox"/>	<input type="checkbox"/>	<input type="checkbox"/>	-
PRAKTI 2615	<input type="checkbox"/>	<input type="checkbox"/>	<input type="checkbox"/>	<input type="checkbox"/>	-	<input type="checkbox"/>	<input type="checkbox"/>	<input type="checkbox"/>	<input type="checkbox"/>	-	<input checked="" type="checkbox"/>	<input type="checkbox"/>	-	<input type="checkbox"/>	<input type="checkbox"/>	<input type="checkbox"/>	<input type="checkbox"/>	<input type="checkbox"/>	-
PRAKTI 2615/R	<input type="checkbox"/>	<input type="checkbox"/>	<input type="checkbox"/>	<input type="checkbox"/>	-	<input type="checkbox"/>	<input type="checkbox"/>	<input type="checkbox"/>	<input type="checkbox"/>	-	<input checked="" type="checkbox"/>	<input type="checkbox"/>	-	<input type="checkbox"/>	<input type="checkbox"/>	<input type="checkbox"/>	<input type="checkbox"/>	<input type="checkbox"/>	-
PRAKTI 2615/2	<input type="checkbox"/>	<input type="checkbox"/>	<input type="checkbox"/>	<input type="checkbox"/>	-	<input type="checkbox"/>	<input type="checkbox"/>	<input type="checkbox"/>	<input type="checkbox"/>	-	<input checked="" type="checkbox"/>	<input type="checkbox"/>	-	<input type="checkbox"/>	<input type="checkbox"/>	<input type="checkbox"/>	<input type="checkbox"/>	<input type="checkbox"/>	-
PRAKTI 3015	<input type="checkbox"/>	<input type="checkbox"/>	-	-	<input type="checkbox"/>	<input type="checkbox"/>	<input type="checkbox"/>	<input type="checkbox"/>	<input type="checkbox"/>	-	<input checked="" type="checkbox"/>	<input type="checkbox"/>	-	<input type="checkbox"/>	<input type="checkbox"/>	<input type="checkbox"/>	<input type="checkbox"/>	<input type="checkbox"/>	-
PRAKTI 3015/R	<input type="checkbox"/>	<input type="checkbox"/>	-	-	<input type="checkbox"/>	<input type="checkbox"/>	<input type="checkbox"/>	<input type="checkbox"/>	<input type="checkbox"/>	-	<input checked="" type="checkbox"/>	<input type="checkbox"/>	-	<input type="checkbox"/>	<input type="checkbox"/>	<input type="checkbox"/>	<input type="checkbox"/>	<input type="checkbox"/>	-
PRAKTI 3015/2	<input type="checkbox"/>	<input type="checkbox"/>	-	-	<input type="checkbox"/>	<input type="checkbox"/>	<input type="checkbox"/>	<input type="checkbox"/>	<input type="checkbox"/>	-	<input checked="" type="checkbox"/>	<input type="checkbox"/>	-	<input type="checkbox"/>	<input type="checkbox"/>	<input type="checkbox"/>	<input type="checkbox"/>	<input type="checkbox"/>	-
PRAKTI DUMPER 2014	-	-	<input type="checkbox"/>	-	-	<input type="checkbox"/>	-	<input type="checkbox"/>	<input type="checkbox"/>	-	<input checked="" type="checkbox"/>	-	-	-	-	-	<input type="checkbox"/>	<input checked="" type="checkbox"/>	-
PRAKTI DUMPER 2014R	-	-	<input type="checkbox"/>	-	-	<input type="checkbox"/>	-	<input type="checkbox"/>	<input type="checkbox"/>	-	<input checked="" type="checkbox"/>	-	-	-	-	-	<input type="checkbox"/>	<input checked="" type="checkbox"/>	-
PRAKTI DUMPER 2314	-	-	<input type="checkbox"/>	-	-	<input type="checkbox"/>	-	<input type="checkbox"/>	<input type="checkbox"/>	-	<input checked="" type="checkbox"/>	-	-	-	-	-	<input type="checkbox"/>	<input checked="" type="checkbox"/>	-
PRAKTI DUMPER 2314R	-	-	<input type="checkbox"/>	-	-	<input type="checkbox"/>	-	<input type="checkbox"/>	<input type="checkbox"/>	-	<input checked="" type="checkbox"/>	-	-	-	-	-	<input type="checkbox"/>	<input checked="" type="checkbox"/>	-
PRAKTI DUMPER 2614	-	-	<input type="checkbox"/>	-	-	<input type="checkbox"/>	-	<input type="checkbox"/>	<input type="checkbox"/>	-	<input checked="" type="checkbox"/>	-	-	-	-	-	<input type="checkbox"/>	<input checked="" type="checkbox"/>	-
PRAKTI DUMPER 2614R	-	-	<input type="checkbox"/>	-	-	<input type="checkbox"/>	-	<input type="checkbox"/>	<input type="checkbox"/>	-	<input checked="" type="checkbox"/>	-	-	-	-	-	<input type="checkbox"/>	<input checked="" type="checkbox"/>	-
PRAKTI DUMPER 2614/2	-	-	<input type="checkbox"/>	-	-	<input type="checkbox"/>	-	<input type="checkbox"/>	<input type="checkbox"/>	-	<input checked="" type="checkbox"/>	-	-	-	-	-	<input type="checkbox"/>	<input checked="" type="checkbox"/>	-

	1	2	3	4	5	6	7	8	9	10	11	12	13	14	15	16	17	18	19
WOOD 2012	■	□	□	-	-	-	-	□	□	-	■	□	-	□	□	□	□	□	-
WOOD 2012/R	■	□	□	-	-	-	-	□	□	-	■	□	-	□	□	□	□	□	-
WOOD 2012 KIPP	■	□	□	-	-	-	-	□	□	-	■	□	-	□	□	□	□	□	-
WOOD 2012/R KIPP	■	□	□	-	-	-	-	□	□	-	■	□	-	□	□	□	□	□	-
WOOD 2312	■	□	□	□	-	-	-	□	□	-	■	□	-	□	□	□	□	□	-
WOOD 2312/R	■	□	□	□	-	-	-	□	□	-	■	□	-	□	□	□	□	□	-
WOOD 2312/2	■	□	□	□	-	-	-	□	□	-	■	□	-	□	□	□	□	□	-
WOOD 2312 KIPP	■	□	□	□	-	-	-	□	□	-	■	□	-	□	□	□	□	□	-
WOOD 2312/R KIPP	■	□	□	□	-	-	-	□	□	-	■	□	-	□	□	□	□	□	-
WOOD 2312/2 KIPP	■	□	□	□	-	-	-	□	□	-	■	□	-	□	□	□	□	□	-
WOOD 2612	■	□	□	□	-	-	-	□	□	-	■	□	-	□	□	□	□	□	-
WOOD 2612/R	■	□	□	□	-	-	-	□	□	-	■	□	-	□	□	□	□	□	-
WOOD 2612/2	■	□	□	□	-	-	-	□	□	-	■	□	-	□	□	□	□	□	-
WOOD 2612 KIPP	■	□	□	□	-	-	-	□	□	-	■	□	-	□	□	□	□	□	-
WOOD 2612/R KIPP	■	□	□	□	-	-	-	□	□	-	■	□	-	□	□	□	□	□	-
WOOD 2612/2 KIPP	■	□	□	□	-	-	-	□	□	-	■	□	-	□	□	□	□	□	-

■ standard □ option – unavailable

Dear all! Thank you for your interest in our products. We make every effort to ensure that the information contained in this catalogue is up-to-date and accurate. We would like to inform you that due to the continuous improvement of our products, we are not responsible for the content of the catalogue and the information contained therein is not binding, and their nature is only informative, they do not constitute an offer within the meaning of civil law. This catalogue does not contain any promise or guarantee, also regarding the updating, correction, supplementation and quality of the information. All information contained in this catalogue, as well as the described products and services may be changed or updated by Temared Sp. z o.o. The "TEMARED" trademark, as well as its products, logos, symbols and slogans are the property of Temared Sp. z o.o. Unauthorized use of these trademarks is strictly prohibited.

Sehr geehrte Damen und Herren! Herzlichen Dank für Ihr Interesse an unseren Produkten. Wir bemühen uns unsererseits, dass die in diesem Katalog enthaltenen Informationen aktuell und korrekt sind. Wir möchten Sie darauf hinweisen, dass wir aufgrund der ständigen Verbesserung unserer Produkte keine Verantwortung für den Inhalt des Katalogs übernehmen und die darin enthaltenen Informationen unverbindlich sind, rein informativen Charakter haben und kein Angebot im Sinne des Zivilrechts darstellen. Dieser Katalog enthält keinerlei Versprechungen oder Garantien, auch nicht hinsichtlich der Aktualität, Korrektheit, Ergänzung und Qualität der Informationen. Alle in diesem Katalog enthaltenen Informationen sowie die beschriebenen Produkte und Dienstleistungen können von Temared Sp. z o.o. ohne vorherige Ankündigung geändert oder aktualisiert werden. Die Marke "TEMARED" sowie ihre Produkte, Logos, Symbole und Slogans sind Eigentum der Temared Sp. z o.o. Die unberechtigte Verwendung dieser Marken ist strengstens untersagt.

Mesdames et Messieurs, nous remercions de votre intérêt pour nos produits. Toutes les informations de ce catalogue ont été élaborées sur la base des meilleures informations disponibles et contrôlées avec le plus grand soin. Cependant il n'est pas possible d'exclure toute erreur liée aux modifications de nos produits que nous nous appliquons constamment à corriger ou modifier. C'est pourquoi les données proposées n'impliquent aucune obligation, garantie ni explicite ni implicite particulièrement quant à la nature, la commercialisation, l'aptitude pour les applications prévues. Nous nous réservons le droit de réaliser des modifications ou changements sans notification préalable. TEMARED SP Z O.O. a le droit d'exécuter les changements décrits ci-dessus aux informations, aux produits et aux services à tout moment. Les photos incluses dans ce catalogue appartiennent exclusivement à TEMARED SP Z O.O. TEMARED SP Z O.O. détient l'ensemble des droits de propriété de logo, de la marque de TEMARED, de ses symboles, noms commerciaux et slogans. Il est interdit d'utiliser le logo ou la marque de TEMARED.

Szanowni Państwo! Bardzo dziękujemy za zainteresowanie naszymi produktami. Ze swojej strony dokładamy wszelkich starań aby zapewnić aktualność i dokładność informacji zawartych w tym katalogu. Pragniemy poinformować, że ze względu na ciągłe udoskonalenie produktów nie ponosimy odpowiedzialności w związku z treścią katalogu i informacje w nim zawarte nie są wiążące, a ich charakter jest wyłącznie informacyjny, nie stanowią one oferty w rozumieniu prawa cywilnego. Niniejszy katalog nie zawiera żadnego przyrzeczenia lub gwarancji, także odnośnie aktualizacji, korekcyj, uzupełnienia i jakości informacji. Wszystkie informacje zawarte w tym katalogu, jak również opisane produkty i usługi mogą być bez wcześniejszego zawiadomienia zmieniane lub aktualizowane przez Temared Sp. z o.o. Znak towarowy „TEMARED”, a także jej produkty, logo, symbole i slogany są własnością Temared Sp. z o.o. Nieuprawnione używanie tych znaków towarowych jest surowo zabronione.



PRO 2615



ECO 2010



PURPOSE: the perfect solution for home and business use

COMFORT: openable and removable rear side

SAFETY: solid frame, reputable axle suppliers

CONVENIENCE: a large selection of options, compatible with other models of light trailers

CONSTRUCTION: fixed or tilting drawbar, jockey wheel in standard in all models



VERWENDUNG: ideal für den privaten und geschäftlichen Gebrauch

KOMFORT: hintere Bordwand kann geöffnet und abgenommen werden

SICHERHEIT: stabiler Rahmen, Achsen von renommierten Lieferanten

PRAKTIKABILITÄT: große Auswahl an Optionen, die mit anderen leichten Anhängermodellen kompatibel sind

KONSTRUKTION: feste oder kippbare Deichsel, Stützrad serienmäßig bei allen Modellen



UTILISATION: solution idéale pour diverses tâches ménagères et professionnelles

CONFORT: ridelle arrière ouvrable et amovible

SÉCURITÉ: châssis solide, essieux de fournisseurs renommés

COMMODITÉ: grand choix d'options compatibles avec d'autres modèles de remorques bagagères

CONSTRUCTION: timon rigide ou pliable, roue jockey pour tous les modèles



PRZEZNACZENIE: idealne rozwiązanie do prac domowych oraz w firmie

WYGODA: tylna burta otwierana i demontowalna

BEZPIECZEŃSTWO: stabilna rama, osie renomowanych dostawców

UDOGODNIENIA: duży wybór opcji, kompatybilnych z innymi modelami przyczep lekkich

KONSTRUKCJA: dyszel stały lub uchylny, bardzo solidna i wytrzymała rama

- possibility of storing the trailer in vertical position on rear side
- Möglichkeit, den Anhänger auf der hinteren Bordwand in einer aufrechten Position zu lagern
- possibilité de poser la remorque en position verticale sur la ridelle arrière
- możliwość przechowywania przyczepy na tylnej burcie w pozycji pionowej



- modern sides design, based on the shape of aluminum sides
- neues Design der Bordwände auf der Grundlage des Aluminiumbordwändendesigns
- nouveau design des ridelles, ressemblant celles en aluminium
- nowoczesny design burt wzorowany na kształcie burt aluminiowych



- lightweight, solid, black plastic mudguard
- leichte, robuste, schwarze Kunststoff-Kotflügel
- garde-boues en plastique noir, légers et durables
- lekkie, wytrzymałe, czarne plastikowe błotniki



- waterproof and anti slip plywood floor
- wasserfester, rutschhemmender Siebdruckbodenplatte
- plancher en contreplaqué imperméable et antidérapant
- podłoga ze sklejki wodoodpornej, antypoślizgowej



- each model available with tilt drawbar (KIPP version)
- jedes Modell auch mit kippbarer Deichsel erhältlich (KIPP-Version)
- chaque modèle disponible avec un timon pliable
- każdy model dostępny również z uchylnym dyszlem (wersja KIPP)



ECO 2612/2 KIPP

- openable and removable rear side
- hintere Bordwand klappbar und abnehmbar
- ridelle arrière ouvrable et facilement amovible
- tylna burta otwierana oraz łatwo demontowalna

ECO 2012 KIPP



- centrally positioned jockey wheel improves the stability of trailer.
- Zentral platziertes Stützrad für eine bessere Stabilität des Anhängers
- chaque modèle disponible avec un timon pliable
- centralnie umieszczone koło podporowe poprawiające stabilność przyczepy

ECO 2010





1 flat cover, Flachplane
bâche plate, pokrowiec płaski



2 flat cover frame, Hochspiegel HO
arceau HO, stelaż HO

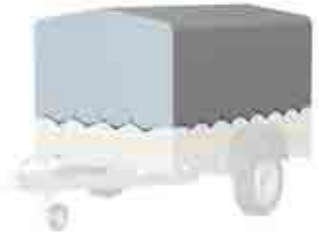

3 cover 80 cm, Plane 80 cm
bâche haute 80 cm, pokrowiec 80 cm



4 cover 110 cm, Plane 110 cm
bâche haute 110 cm, pokrowiec 110 cm



5 steel extensions 40 cm,
Stahlbordwandaufsatz 40 cm,
réhausse de ridelles en acier 40 cm,
burty BIS stal 40 cm



6 mesh extensions 40 cm,
Laubgitteraufsatz 40 cm,
réhausse de ridelles grillagées 40 cm,
burty BIS stal siatkowe 40 cm

7 alu cover, ALU Deckel,
capot alu, pokrywa ALU



8 ladderrack, Reling,
porte-échelle, reling



9 jockey wheel, Stützrad,
roue jockey, koło podporowe



10 spare wheel, Ersatzrad,
roue de secours, koło zapasowe



	1	2	3	4	5	6	7	8	9	10
ECO 1510 / ECO 1510 KIPP	<input type="checkbox"/>	<input type="checkbox"/>	<input type="checkbox"/>	-	<input type="checkbox"/>	<input type="checkbox"/>	-	<input type="checkbox"/>	<input checked="" type="checkbox"/>	-
ECO 2010 / ECO 2010 KIPP	<input type="checkbox"/>	<input type="checkbox"/>	<input type="checkbox"/>	-	<input type="checkbox"/>	<input type="checkbox"/>	<input type="checkbox"/>	<input type="checkbox"/>	<input checked="" type="checkbox"/>	<input type="checkbox"/>
ECO 2012 / ECO 2012 KIPP	<input type="checkbox"/>	<input type="checkbox"/>	<input type="checkbox"/>	-	<input type="checkbox"/>	<input type="checkbox"/>	<input type="checkbox"/>	<input type="checkbox"/>	<input checked="" type="checkbox"/>	<input type="checkbox"/>
ECO 2312 / ECO 2312 KIPP	<input type="checkbox"/>	<input type="checkbox"/>	<input type="checkbox"/>	<input type="checkbox"/>	<input type="checkbox"/>	<input type="checkbox"/>	<input type="checkbox"/>	<input type="checkbox"/>	<input checked="" type="checkbox"/>	<input type="checkbox"/>
ECO 2612 / ECO 2612 KIPP	<input type="checkbox"/>	<input type="checkbox"/>	<input type="checkbox"/>	<input type="checkbox"/>	<input type="checkbox"/>	<input type="checkbox"/>	<input type="checkbox"/>	<input type="checkbox"/>	<input checked="" type="checkbox"/>	<input type="checkbox"/>
ECO 2612/2 / ECO 2612/2KIPP	<input type="checkbox"/>	<input type="checkbox"/>	<input type="checkbox"/>	<input type="checkbox"/>	<input type="checkbox"/>	<input type="checkbox"/>	<input type="checkbox"/>	<input type="checkbox"/>	<input checked="" type="checkbox"/>	<input type="checkbox"/>

■ standard option - unavailable



ECO 2010

- The strong bolted construction ensures many years of trouble-free use. The supporting frame is made of bent profiles made of galvanized steel. The floor is made of high-quality, waterproof, anti-slip plywood.
- Die robuste, verschraubte Konstruktion gewährleistet einen langjährigen, störungsfreien Einsatz. Unterstell aus gebogenen Profilen aus verzinktem Stahlblech. Der Boden wurde aus hochwertiger, wasserfester und rutschfester Siebdruckplatte hergestellt.
- La construction boulonnée solide garantit de nombreuses années d'utilisation sans problème. Le châssis fait de profilés pliés en tôle d'acier galvanisé. Le plancher en conreplaque de haute qualité, imperméable et antidérapant.
- Mocna konstrukcja skręciana zapewnia wieloletnie i bezproblemowe użytkowanie. Rama nośna wykonana z profili giętych z blachy stalowej ocynkowanej. Podłoga wykonana z wysokiej jakości sklejki wodoodpornej antypoślizgowej.

ECO 1510

- durable, solid steel side extensions increase the load space by 40 cm
- stabiler Stahlbordwandaufsatz erhöht die Ladefläche um 40 cm
- réhausses de ridelles pleines et durables augmentent l'espace de chargement de 40cm
- wytrzymałe, pełne burty BIS podwyższają przestrzeń ładunkową o 40 cm



ECO 1510



- mesh extensions increase the load surface by 40 cm and provide ventilation of the load
- Der Laubgitteraufsatz erhöht den Laderaum um 40 cm. Die Gitterkonstruktion verringert den Luftwiderstand
- réhausses de ridelles grillagées augmentent l'espace de chargement de 40cm
- burty siatkowe BIS podwyższają przestrzeń ładunkową o 40 cm jednocześnie dzięki ażurowej konstrukcji zapewnia wentylację ładunku

ECO 1510

- ladderrack allows for safety fastening of load and transport of bulky loads
- vordere Reling ermöglicht sichere Befestigung und Transport größerer Ladungen
- porte-échelle avant permet d'attacher et de transporter en toute sécurité les marchandises volumineuses
- reling przedni umożliwia bezpieczne zamocowanie, przewożenie ładunków gabarytowych



- waterproof and durable cover protects the load against weather conditons
- wasserdichte, starke Plane sichert die Ladung vor Wettereinflüssen
- bâche imperméable et durable protège la cargaison contre les différentes conditions climatiques
- wodoodporna, wytrzymała plandeka zabezpiecza ładunek przed warunkami atmosferycznymi

ECO 1510















- lightweight aluminium cover equipped with rails for fixing of box roof racks or bicycle racks
- leichter Alu Deckel mit Relingen für die Montage von Auto- und Fahrradträgern
- capot en alu léger équipé de rails pour le montage p.ex. de coffre de toit ou de porte-vélos
- lekka aluminiowa pokrywa wyposażona w relingi do montażu bagażników samochodowych box, rowerowych

- key lock to prevent unauthorised access to the load
- Schlüsselschloss zur Sicherung gegen unautorisierten Zugang zur Ladung
- serrure à clé protège la cagaison contre tout accès non autorisé
- zamek z kluczykiem zabezpiecza ładunek przed dostępem osób niepowołanych

ECO 1510



ECO**TEMARED**
all about trailers

MODEL	GVWR(kg)	LOAD CAPACITY(kg)	INTERNAL DIMENSIONS (mm)	SUSPENSION	BRAKES	TILTING	WHEELS	
MODELL	zGG (kg)	NUTZLAST(kg)	LADEFLÄCHE (mm)	AUFHÄNGUNG	BREMSE	KIPPBAR	RÄDER	
MODÈLE	PTAC (kg)	CAPACITÉ DE CHARGE(kg)	DIMENSIONS INTÉRIEURES (mm)	SUSPENSION	FREINS	BASCULANT	ROUES	
MODEL	DMC (kg)	ŁADOWNOŚĆ(kg)	POWIERZCHNIA ŁADUNKOWA (mm)	ZAWIESZENIE	HAMULCE	UCHYLNA	KOŁA	
ECO 1510	300 - 750	642	1470x1060x300		1 x 750 kg	-	-	155/70 R13
ECO 1510 [KIPP]	300 - 750	640	1470x1060x300		1 x 750 kg	-	+	155/70 R13
ECO 2010	300 - 750	634	2010x1060x300		1 x 750 kg	-	-	155/70 R13
ECO 2010 [KIPP]	300 - 750	632	2010x1060x300		1 x 750 kg	-	+	155/70 R13
ECO 2012	300 - 750	628	2010x1260x300		1 x 750 kg	-	-	155/70 R13
ECO 2012 [KIPP]	300 - 750	624	2010x1260x300		1 x 750 kg	-	+	155/70 R13
ECO 2312	300 - 750	620	2305x1260x300		1 x 750 kg	-	-	155/70 R13
ECO 2312 [KIPP]	300 - 750	616	2305x1260x300		1 x 750 kg	-	+	155/70 R13
ECO 2612	300 - 750	599	2640x1260x300		1 x 750 kg	-	-	155/70 R13
ECO 2612 [KIPP]	300 - 750	595	2640x1260x300		1 x 750 kg	-	+	155/70 R13
ECO 2612/2	300 - 750	558	2640x1260x300		2 x 750 kg	-	-	155/70 R13
ECO 2612/2 [KIPP]	300 - 750	554	2640x1260x300		2 x 750 kg	-	+	155/70 R13



1 non-braked axle 750 kg
1 Achse ungebremst 750 kg
1 essieu non freiné de 750 kg
1 oś niehamowana 750 kg



2 non-braked axles 750 kg each
2 ungebremste Achsen jeweils 750 kg
2 essieux de pression non freinés de 750 kg
2 niehamowane osie 750 kg każda

Dear all! Thank you for your interest in our products. We make every effort to ensure that the information contained in this catalogue is up-to-date and accurate. We would like to inform you that due to the continuous improvement of our products, we are not responsible for the content of the catalogue and the information contained therein is not binding, and their nature is only informative, they do not constitute an offer within the meaning of civil law. This catalogue does not contain any promise or guarantee, also regarding the updating, correction, supplementation and quality of the information. All information contained in this catalogue, as well as the described products and services may be changed or updated by Temared Sp. z o.o. The "TEMARED" trademark, as well as its products, logos, symbols and slogans are the property of Temared Sp. z o.o. Unauthorized use of these trademarks is strictly prohibited.

Sehr geehrte Damen und Herren! Herzlichen Dank für Ihr Interesse an unseren Produkten. Wir bemühen uns unsererseits, dass die in diesem Katalog enthaltenen Informationen aktuell und korrekt sind. Wir möchten Sie darauf hinweisen, dass wir aufgrund der ständigen Verbesserung unserer Produkte keine Verantwortung für den Inhalt des Katalogs übernehmen und die darin enthaltenen Informationen unverbindlich sind, rein informativen Charakter haben und kein Angebot im Sinne des Zivilrechts darstellen. Dieser Katalog enthält keinerlei Versprechungen oder Garantien, auch nicht hinsichtlich der Aktualität, Korrektheit, Ergänzung und Qualität der Informationen. Alle in diesem Katalog enthaltenen Informationen sowie die beschriebenen Produkte und Dienstleistungen können von Temared Sp. z o.o. ohne vorherige Ankündigung geändert oder aktualisiert werden. Die Marke "TEMARED" sowie ihre Produkte, Logos, Symbole und Slogans sind Eigentum der Temared Sp. z o.o. Die unberechtigte Verwendung dieser Marken ist strengstens untersagt.

Mesdames et Messieurs, nous remercions de votre intérêt pour nos produits. Toutes les informations de ce catalogue ont été élaborées sur la base des meilleures informations disponibles et contrôlées avec le plus grand soin. Cependant il n'est pas possible d'exclure toute erreur liée aux modifications de nos produits que nous nous appliquons constamment à corriger ou modifier. C'est pourquoi les données proposées n'impliquent aucune obligation, garantie ni explicite ni implicite particulièrement quant à la nature, la commercialisation, l'aptitude pour les applications prévues. Nous nous réservons le droit de réaliser des modifications ou changements sans notification préalable. TEMARED SP Z O.O. a le droit d'exécuter les changements décrits ci-dessus aux informations, aux produits et aux services à tout moment. Les photos incluses dans ce catalogue appartiennent exclusivement à TEMARED SP Z O.O. TEMARED SP Z O.O. détient l'ensemble des droits de propriété de logo, de la marque de TEMARED, de ses symboles, noms commerciaux et slogans. Il est interdit d'utiliser le logo ou la marque de TEMARED.

Szanowni Państwo! Bardzo dziękujemy za zainteresowanie naszymi produktami. Ze swojej strony dokładamy wszelkich starań aby zapewnić aktualność i dokładność informacji zawartych w tym katalogu. Pragniemy poinformować, że ze względu na ciągłe udoskonalenie produktów nie ponosimy odpowiedzialności w związku z treścią katalogu i informacje w nim zawarte nie są wiążące, a ich charakter jest wyłącznie informacyjny, nie stanowią one oferty w rozumieniu prawa cywilnego. Niniejszy katalog nie zawiera żadnego przyrzeczenia lub gwarancji, także odnośnie aktualizacji, korekcji, uzupełnienia i jakości informacji. Wszystkie informacje zawarte w tym katalogu, jak również opisane produkty i usługi mogą być bez wcześniejszego zawiadomienia zmieniane lub aktualizowane przez Temared Sp. z o.o. Znak towarowy „TEMARED”, a także jej produkty, logo, symbole i slogany są własnością Temared Sp. z o.o. Nieuprawnione używanie tych znaków towarowych jest surowo zabronione.

NOTES:

.....

.....

.....

.....

.....

.....

.....

.....

.....

.....

.....

NOTES:

.....

.....

.....

.....

.....

.....

.....

.....

.....

.....

.....

NOTES:

.....

.....

.....

.....

.....

.....

.....

.....

.....

.....

.....

Contact | Kontakt

TEMARED Sp. z o.o.
al. Lotników Polskich 1
21-040 Świdnik,
Poland

Sales Department
tel.: +48 81 451 15 32
email:
sales@temared.com

www.temared.com